



sonim[®] XP5s USER GUIDE

Table of Contents

GENERAL INFORMATION 4

Disposal of Old Electrical and Electronic Equipment.....	4
Disposal of Battery	4
Guideline for Headphone and Earphone	4
Register your Phone	4
Phone Models Covered.....	4
Sonim Support Information	4
Options Commonly Used Across Menu Items	4

SAFETY GUIDELINES 5

Avoid High Temperatures.....	6
Personal Medical Devices	6
Child Safety.....	6
Emergency Calls.....	6

BATTERY USAGE 6

Inserting the Battery	6
Charging the Battery	7
Verifying and Optimizing Battery Usage	7
Tips to Extend the Battery Life.....	8
Warning.....	8

YOUR SIM CARD 8

Removing the Back Cover	8
Inserting the SIM Cards.....	9
Inserting Memory Card.....	9

GETTING STARTED 10

What is in the Box?.....	10
Phone Specifications.....	10

USING YOUR SONIM XP5S 11

Switching On the Phone.....	12
Setting Up Your Phone.....	12
Managing Home Screen.....	12
key Shortcuts.....	13
Notification Bar Icons	13
Phone Operations Without SIM Card	14
capturing a Screenshot	14
Text Entry Options.....	14
To Enter a Word.....	15
To Insert a Number.....	15

HOME SCREEN MENU OPTIONS 16

My Notifications.....	16
Wallpaper	16
Search.....	16
Home Screen Shortcuts	16
System Settings.....	16
Manage Apps.....	16

QUICK SETTINGS 17

Mobile Hotspot	17
Wi-Fi	17
Data.....	17
Bluetooth.....	17
Torch	17
Airplane Mode.....	17
Profiles	17

MISSED EVENTS 17

NETWORK & INTERNET 18

Wi-Fi	18
Mobile Network.....	19
Data Usage	19
Hotspot and Tethering.....	19
VPN	20
Ethernet.....	20
Airplane Mode.....	20
Advanced Calling.....	20
Reset Network Sttings.....	20

CONNECTED DEVICES 20

Bluetooth.....	21
USB.....	21

APPS & NOTIFICATIONS 22

Apps Info.....	22
Notification.....	22
App Permissions.....	22
Wireless Emergency Alerts.....	22

BATTERY SETTINGS 23

Battery.....	23
--------------	----

DISPLAY SETTINGS 23

Display	23
---------------	----

SOUND SETTINGS	24	SENDING MESSAGES	35
Profile	24	Sending SMS/MMS Message	35
Sound	25	Deleting Messages	35
Other Sound	25	Managing Message Settings.....	36
Notification.....	25		
Voice Noise Cancellation.....	25	VERIZON SERVICES	37
		Push to Talk+	37
STORAGE SETTINGS	26	My Verizon	37
Storage.....	26	Cloud.....	37
		Fieldforce Manager.....	37
SECURITY & LOCATION	26		
Device Security	26	SONIM SCOUT	38
Privacy	26	Setup.....	38
		Utilities.....	38
ACCESSIBILITY SETTINGS	28	Support.....	38
Accessibility	28		
Screen Readers	28	APPLICATIONS	39
Display	28	Music.....	39
		FM Radio.....	39
SYSTEM SETTINGS	29	File Explorer	40
Home Screen Shortcuts.....	29	Backup and Restore	40
Programmable Key.....	29	Downloads	40
Accessories.....	29	Voice Commands	40
Languages & Input.....	29		
Gestures.....	29	TOOLS	41
Date & Time	30	Clock	41
Reset Options	30	Calculator	41
About Phone.....	30	SIM Toolkit.....	42
		Sound Recorder	42
SYSTEM UPDATES	30		
		OTHER APPLICATIONS	43
MANAGING CONTACTS	31	Camera.....	43
Adding New Contact for the First Time	31	Calendar	43
Adding a New Contact	31	Gallery	43
Viewing Contact Details	31	Browser.....	43
Sending a Message from Contacts	31		
Dialing a Number from Contacts.....	31	REGULATORY INFORMATION - USA MARKET	44
Editing the Contact Details.....	31	RF Exposure Information (SAR)	44
Menu Options	31	Federal Communication Commission Interference Statement.....	44
Managing Contact Settings.....	32	FCC Caution	44
		HAC Rating	45
MANAGING CALL SETTINGS	33	ISED RF Exposure Statement (IC).....	45
Making a Call	33	End User License Agreement(EULA)	45
Dialing a Number via Contact	33		
Adding a Contact from Home Screen	33	HAZARDOUS LOCATION USAGE WARNING	46
Viewing Call History	33		
Deleting Call History	33	INDEX	47
Speed Dial Settings	33		
Call Settings.....	33		

GENERAL INFORMATION

Copyright © 2020 Sonim Technologies, Inc.

Sonim and the Sonim logo are trademarks of Sonim Technologies, Inc. Other company and product names may be trademarks or registered trade-marks of the respective owners with whom they are associated.

DISPOSAL OF OLD ELECTRICAL AND ELECTRONIC EQUIPMENT



The symbol of the crossed-out wheeled bin indicates that within the countries in the European Union, this product, and any enhancements marked with this symbol, cannot be disposed as unsorted waste but must be taken to separate collection at their end-of-life.

DISPOSAL OF BATTERY



Please check local regulations for disposal of batteries. The battery should never be placed in municipal waste. Use a battery disposal facility if available.

GUIDELINE FOR HEADPHONE AND EARPHONE



To prevent possible hearing damage, please do not listen at high volume levels for long periods.

REGISTER YOUR PHONE

Please register your phone at http://sonimxperience.com/registration_portal/portal/registration.php to receive product information and updates.



Sonim devices are covered by a 3-Year comprehensive warranty. The battery is covered by a 1-Year limited warranty.

Congratulations on the purchase of a Sonim XP5s (XP5800) mobile phone! This phone has an intuitive feature-rich user interface, which allows you to make the best use of offered functions.

PHONE MODELS COVERED

This user guide covers Sonim XP5s phone with the model number XP5800.

SONIM SUPPORT INFORMATION

For additional product and support information, visit www.sonimtech.com.

OPTIONS COMMONLY USED ACROSS MENU ITEMS

The following are common actions used across various menu items:

OK	Confirms an action. Use the Center selection key to perform this function.
BACK	Use this key to display the previous screen.
MENU	Moves the current working application to the recent applications list/background and displays menu screen.
RECENT	Displays the thumbnails of the applications that you have worked on recently. To remove any application from this list, Select Remove from list from option.

SAFETY GUIDELINES

Please read and understand the following safety guidelines before you use the phone. These guidelines provide details to enable you to operate your phone safely and conform to any legal requirements regarding the use of cellular phones.



Do not use the phone at a refueling point. Observe restrictions when using radio equipment at fuel depots, chemical plants or where blasting operations are in progress.



Electrical interference may obstruct the use of your phone. Observe restrictions in hospitals and near medical equipment.



Switch off your cellular phone when in an aircraft. Wireless phones can cause interference or danger to an aircraft. In an aircraft, the phone can be used in flight mode.



Do not expose the device to high temperatures (in excess of 55°C).



Adhere to road safety laws. Do not hold/use a phone while you are driving; find a safe place to stop first. Use hands-free microphone while you are driving.



Avoid using the phone in close proximity to personal medical devices, such as pacemakers and hearing aids.



Use only Sonim XP5800 approved charging equipment to charge your phone and avoid damage to your phone.



The symbol of the crossed-out wheeled bin indicates that this product and any enhancements marked with this symbol, cannot be disposed as unsorted waste but must be taken to separate collection at their end-of-life.



Ensure that only qualified personnel install or repair your phone.



The Sonim XP5800 is water-proof and can be submerged to 2 meters for 30 minutes.

Ensure that the audio connector and the SIM slot are properly closed. This will prevent the deposit of water droplets on the connectors, when the phone is immersed in water.

Water droplets may condense under the display cover if the phone is immersed in water with significant drop in temperature. This does not indicate water leakage. The droplets will disappear at room temperature.

The Sonim XP5800 is dust-resistant, rugged and shock-resistant. However, it is not dust-proof or unbreakable if subjected to overwhelming impact. For best results and long product life, one should protect the Sonim XP5800 from salt water, dust and strong impacts.

AVOID HIGH TEMPERATURES

Leaving the device in hot or cold places, such as in a closed car in summer or winter conditions, reduces the capacity and lifetime of the battery. For the best results, try to use the device between -20°C and +55°C (-4°F and 131°F). A device with a hot or cold battery may not work temporarily, even when the battery is fully charged. Battery performance is particularly limited in temperatures well below freezing.

PERSONAL MEDICAL DEVICES

Mobile phones may affect the operation of cardiac pacemakers and other implanted equipment. Please avoid placing the mobile phone over the pacemaker, for example in your breast pocket. When using the mobile phone, place it at the ear opposite the pacemaker. If a minimum distance of 15 cm (6 inches) is kept between the mobile phone and the pacemaker, the risk of interference is limited. If you suspect that interference is taking place, immediately turn off your mobile phone. Contact your cardiologist for more information. For other medical devices, consult your physician and the manufacturer of the device. Comply with instructions to switch off the device or deactivate the RF transmitter when required, especially when posted in hospitals and airplanes. Equipment used in these places may be sensitive to radio waves emitted from the device and adversely affect their operation. Also, observe restrictions at gas stations or other areas with flammable atmosphere or when close to electro-explosive devices.

CHILD SAFETY

Do not allow children to play with your mobile phone or its accessories. Keep it out of their reach. They could hurt themselves or others, or could accidentally damage the mobile phone or accessories. Your mobile phone and its accessories may contain small parts, which could be detached and create a choking hazard.

EMERGENCY CALLS

Mobile phones operate using radio signals, which cannot guarantee connection under all conditions. Therefore you should never rely solely upon any mobile phone for essential communications (e.g. medical emergencies). Emergency calls may not be possible in all areas, on all cellular networks, or when certain network services and/or mobile phone features are in use. Check with your local service provider.

WARNING



It is not allowed to connect any external devices to all ports/interface (USB, XPand and SecureAudio Connector) in Hazardous area.

BATTERY USAGE

Sonim XP5s phone comes with a removable battery. For any battery related queries, contact Sonim customer support.

- Use only a Sonim XP5800 certified battery that is designed for this phone model.
- The use of other batteries may void the warranty terms of your phone and cause damage.
- It is recommended to protect the battery from extreme temperature environments and moisture.
- Please keep the battery out of the reach of children.

INSERTING THE BATTERY

1. UNSCREW COVER

To open the battery cover, rotate both the battery cover screws in a counter clockwise direction (as shown in the figure). Sometimes, the battery cover may be tight and some extra effort is required to open it. You can use the screwdriver provided to open the screws.

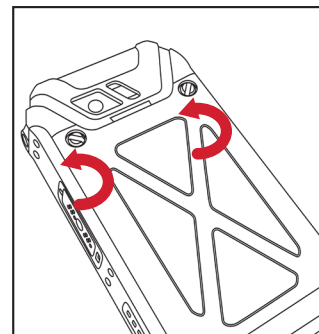

2. LIFT THE COVER

Lift the back cover to reveal the battery slot.

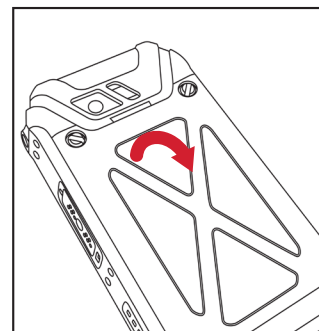

3. INSERT BATTERY

Insert the battery and flush into the battery slot such that the three metallic contacts at the top of the battery are aligned with four metallic contacts at the bottom of the battery.

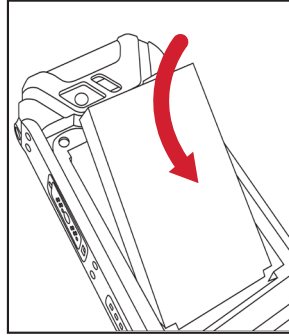

4. CLOSE COVER

Close the battery cover. Rotate the battery cover screws in clockwise direction. You can use the screwdriver provided to tighten the screws. Ensure not to over-tighten the screws.

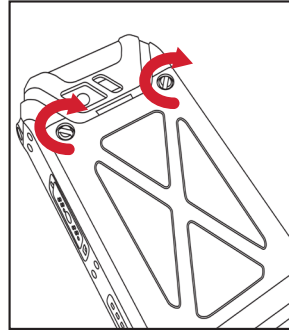

1. INSERT CHARGER

Insert the charger plug into a power outlet.

2. CONNECT TO THE PHONE

The charging port is located in the lower side of the phone, below the back cover. Insert the charger connector to the charging port.

3. CHARGING ANIMATION/ICON

- If the battery is being charged when the phone is switched off, a battery charging animation with current battery level is displayed.
- If the battery is being charged while the phone is switched on, the battery icon on the status bar shows the animation indicating that the battery is being charged.
- Once the battery is fully charged, charging animation is displayed and a pop-up is displayed **“Battery is full Please unplug the charger”**.



CHARGING THE BATTERY

The battery delivered with your mobile phone is not fully charged. We recommend that you charge your mobile for 5 hours before you use your mobile phone for the first time.

Only the power supplies with outputs meet the SELV requirements can be used for charging. The maximum allowable input voltage for the phone is 9v.

There is a risk of explosion while charging if the battery has been replaced by an incorrect type.

If the battery is completely out of charge, it can take several minutes for the charging icon to appear when the charger is connected.

VERIFYING AND OPTIMIZING BATTERY USAGE

You can check the battery usage status and also close some applications to save battery power. In the all application screen, select **Settings (⚙) > Battery (🔋)**.

The current battery level (charging or not charging) is displayed on the top right corner of the screen. For more information on Battery, refer to “Battery” on page 23.

If you stop some apps or services, your device may not work correctly.

TIPS TO EXTEND THE BATTERY LIFE

Follow these tips to extend your phone's battery life.

- If you are not using Wi-Fi, Bluetooth, or GPS, use the **Settings** to turn them off. The GPS setting is located in **Settings > Security & location > Privacy > Location**.
- Set screen brightness to **Low** and set a shorter Sleep timeout (15 seconds). The display settings are located in **Settings > Display**.
- If you are travelling and do not have access to mobile data or Wi-Fi network, switch to Airplane mode. Select **Airplane mode** from **Quick Settings**.

WARNING



ONLY THE BATTERY CAN BE REPLACED IN NON-HAZARDOUS LOCATION.

YOUR SIM CARD

Purchase a SIM card from a mobile operator. The SIM card associates your network services (for example, phone number, data services, and so on) with your phone.

REMOVING THE BACK COVER

1. UNSCREW COVER

To open the battery cover, rotate both the battery cover screws in counter clockwise direction (as shown in the figure).

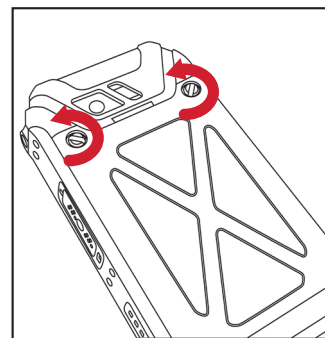

2. LIFT THE COVER

Lift the back cover to reveal the battery slot.

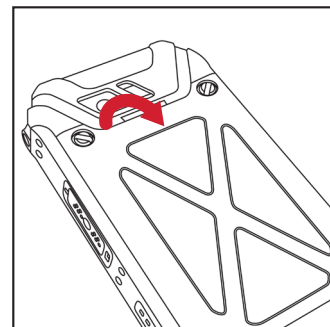

3. USE SONIM SCREWDRIVER

You can use the Sonim provided screwdriver tool to open the screws.

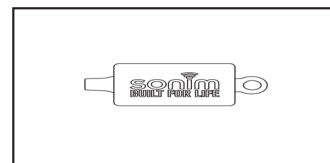

INSERTING THE SIM CARDS

1. UNSCREW COVER

Use the included screwdriver to unscrew the two battery cover screws on the back of the phone.

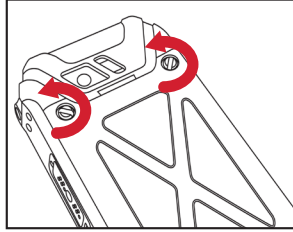

2. LIFT THE COVER

Remove the battery cover and the battery.

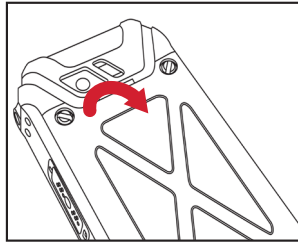

3. INSERT SIM CARD

Open the SIM card tray 1 or tray 2. Insert the SIM card and lock the SIM card tray into place. If two SIM cards are inserted, only SIM card tray 1 works.

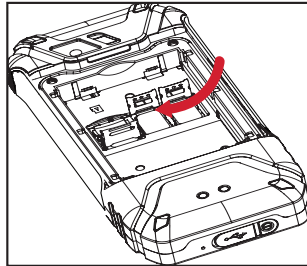

2. PLACE THE MEMORY CARD

Place the memory card in the designated slot and close the silver clip. (as shown in the figure).

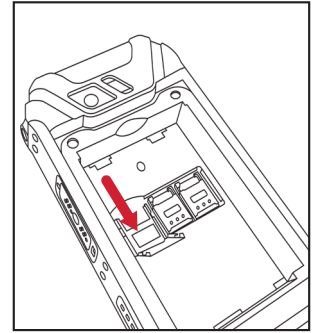

3. USE SONIM SCREWDRIVER

You can use the Sonim provided screwdriver tool to close the screws.

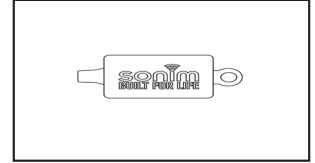

INSERTING MEMORY CARD

1. SLIDE THE SILVER CLIP

Slide (push backward) and lift the silver clip over the designated slot located beside the SIM card slot. (as shown in the figure).

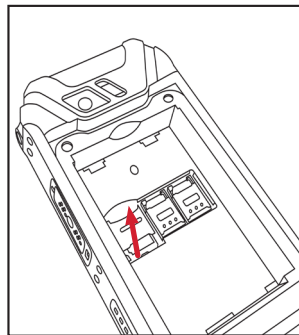

GETTING STARTED

WHAT IS IN THE BOX?

The list of items in the Sonim XP5s phone box are:

- Sonim XP5s
- Battery
- Wall Charger
- USB-C Cable
- Screwdriver
- Quick Start Guide

PHONE SPECIFICATIONS

FEATURE	DESCRIPTION
Chipset	Qualcomm MSM8920
Band	GSM: 850/900/1800/1900MHz UMTS: I/II/IV/V/VIII LTE: B1/B2/B3/B4/B5/B7/B8/B12/ B13/B14/B25/B26/B28/B30/B38/ B41/B66
Antenna	<ul style="list-style-type: none"> • 2X Rx / 1X Tx antenna for LTE and SRLTE • LTE Antennas 0 and 1 should be identical and must have an antenna performance difference of less than 3 dB. • Antenna Isolation between LTE Antennas 0 and 1 must be greater than 10 dB.
Wi-Fi	Support 802.11 a/b/g/n/ac/e/k/r/h Support max 10 connections hotspot
Memory	16GB eMMC 5.1/ 2GB LPDDR3
CONNECTIVITY	
Bluetooth	BT4.x with BLE
Supported Bluetooth Profiles	A2DP, AVRCP, FTP, HFP, HSP, MAP, OPP, PAN, PBAP, SAP, SPP and OBEX
Languages Supported	English and Spanish
Capacity(mAh)	3180mAh, removable Li-ion

FEATURE	DESCRIPTION
Battery Life	Standby: 560 hours Talk time: 22 hours Music playback: 18 hours Video playback: 15 hours Web browsing: 10 hours
PHYSICAL CHARACTERISTICS	
Ambient temperature	-20°C to +55°C
Size	141mm x 63.9 mm x 23mm
Weight	approx. 248 gms
Dedicated keys	PTT Key/Power Key/Volume key (Up and Down)/Speaker key/Emergency key
Ports	Water-proof USB2.0 type-C, High Speed, OTG
DISPLAY	
Size	2.64"
Resolution	320x432 Transmissive
Outdoor Visibility	Yes
Capacity	262K colors
Brightness	400
AUDIO	
Microphone	3 Mics with noise cancellation
Speaker	Front Dual Loud Speaker, Support HD voice and wideband
MULTIMEDIA	
Audio Formats	AMR-NB, AMR-WB, AAC, AAC+, AAC+V2, MP3,V-SELP, AMR 12.65, AMR 6.6,
Video Formats	3GP,MP4, WMV, AVI, MOV, MPEG-2, MPEG-4,H.263, H.264, H-265
Image Formats	JPEG
Graphic Formats	JPEG, PNG, and BMP
FM Radio	Yes
Camera	5MP FF Rear camera, No front camera
LED Torch Light	Yes, also used for camera flash

USING YOUR SONIM XP5s



1. Sonim XPand Connector
2. Microphones
3. USB-C
4. Volume Up / Down
5. PTT Button
6. App Tray
7. Options
8. Clear
9. Answer / Accept
10. Voicemail (Press and Hold)
11. Lock / Unlock Keypad (Press and Hold)
12. Select / Center key
13. Navigation
14. End / Reject / Power On & Off (Press and Hold)
15. Speakerphone
16. Back
17. Display
18. Battery Level Indicator
19. Notification Bar
20. Receiver
21. LED Notification
22. Sonim SecureAudio Connector
23. Emergency Button
24. Charging Pins
25. Battery Under Door
26. SIM Card Slots Under Battery
27. Memory Card Slot Under Battery
28. Battery Door
29. Rear Flash
30. Rear Facing Camera

SWITCHING ON THE PHONE

Press and hold **ON/OFF** Red button for 2 seconds.

When the phone is switched on, it tries to register with the network. After successful registration, the name of the service provider is displayed.

 Ensure that a valid SIM card is inserted in your phone.

SETTING UP YOUR PHONE

For instructions on using your phone's buttons, charger, battery, and other hardware features, check the printed Quick Start Guide provided along with your phone.

When you power **ON** the phone for the first time, a Welcome screen is displayed.

1. When you turn on your device for the first time, **Hello** screen is displayed.
2. **Language selection** screen is displayed: Select either English or Español. Select **Next**.
3. **Accessibility** screen is displayed. On this screen, press green button from the keypad to make an emergency call. Select **Next**.
4. A **Warning** screen is displayed and a message is displayed check if SIM card is inserted.
5. Select **Turn Off** to switch off the device and insert the SIM card.
6. Select **Done** to complete the setup.
7. On Location Consent screen, select **AGREE** to enable hardware acceleration to collect location data.
8. You can use **Up**, **Center** or **Down** key to access assigned application or function.
9. You can use **Left** and **Right** key to access Quick Settings and Missed Events.

To set up your phone, select **START** and follow the instructions as shown on the screen.

Press **OK** on welcome guide to a use the phone.

MANAGING HOME SCREEN

After you complete the phone setup, the home screen is displayed. The home screen is the beginning point to access all the device's features.

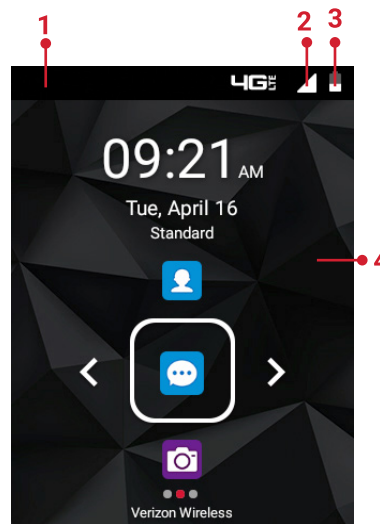



1. Alert Notifications
2. Service Indicator and Signal Strength bar
3. Battery charge indicator
4. Home screen



KEY DESCRIPTION

The navigation keys are located below the display screen.

The **Notifications** on the top of the display screen provides details about various notifications such as missed calls, new messages and missed alarms.

The **System Icons** on the top right side of the screen display the current device status such as wireless and network connection strength and battery level.

KEYS	DESCRIPTION
	Back: Opens the previous screens in the working sequence till the home screen is displayed. Once the home screen is displayed, it remains there even when you press the back key.
	Menu: <ul style="list-style-type: none">• Always positioned in the center of the keypad. Select to view all the applications and device settings.• Long press (for 3 seconds) to enable torch light.• Double press in unlock condition to launch Recent screen.
	Options: Displays the options for the currently active screen.

















KEYS	DESCRIPTION
	Clear: Clears the entered text and deletes the selected file.
 	Speaker: You can place the call on speaker and the icon is enabled only when call is on the speaker. For better result in a noisy environment, hold the device 10-15 cm away from your mouth while speaking on a speaker mode.



















KEY SHORTCUTS

KEY	DESCRIPTION
Speaker key	Long press Speaker key to toggle between sound profiles.
Menu key	Long press Menu key to enable/disable Torch.
Star (*) key	Long press Star (*) key to lock/unlock the device.
Star (*) key	Long press Star (*) key for changing the language while on text input field (Cursor ready).
Star (*) key	Short press Star (*) key to open Emoji screen while in text input mode.
Hash (#) key	Long press Hash (#) key for changing between text modes on text input field (Cursor ready).
Power key	Long press Power key for powering OFF/ ON the device.
Power key	Long press Power key for 15 seconds to restart the device.
Menu key	Double press Menu key to open the recent apps' screen.
PTT key	Single press PTT key to initiate PTT app.

NOTIFICATION BAR ICONS

The icons displayed at the top of the screen provides information about the status of the device. The details such as battery charge status and data service are displayed when the phone is in standby mode. Other indicators such as Bluetooth connectivity status, airplane mode, alarm and Wi-Fi connectivity are displayed, if the feature is activated.

ICONS	DESCRIPTION
	Notification icon
	Battery level indicator
	Battery charging in progress
	Low battery icon
	Low battery notification
	No signal
	Signal strength
	No SIM card
	4G LTE network connected
	Wi-Fi connected
	Bluetooth activated
	Hotspot icon
	Wi-Fi Calling
	Call in progress
	Speaker icon
	FM Radio
	Missed call

ICONS	DESCRIPTION
	New SMS or MMS
	Alarm activated
	Silent mode activated
	Torch light icon
	Vibration mode activated
	Headset connected
	Missed Events notification
	Flight mode activated
	Warranty registration
	Error/information notification - attention required
	Screenshot captured
	Music is played
	Device storage space is running out
	Warranty Registration icon
	PTT Available status icon
	PTT Do Not Disturb
	PTT No Connection
	Roaming icon

PHONE OPERATIONS WITHOUT SIM CARD

You can perform the following operations without inserting a SIM card in your phone.

- Make an emergency call.
- View and modify all settings except few data usage and mobile network related settings.
- Activate and share files through Bluetooth.
- Access the internet using Wi-Fi connectivity.
- Access your phonebook, File explorer multimedia files, all tools and applications.
- View and modify your profile settings.

CAPTURING A SCREENSHOT

You can take the screenshot of the current screen and it is stored in your phone's gallery. To take a screenshot:

1. Ensure that the image to be captured is displayed on the current screen.
2. Press the **Power** and **Volume** down button simultaneously. The screenshot is captured and stored in the gallery. A screen **Capture** () icon is also displayed on the notification bar.

TO CHANGE THE MESSAGE LANGUAGE

While entering the text message or saving the contacts, you can change the message language by press and hold the * key.

You can change the **Language** from **English** to **Español** and vice versa.

TEXT ENTRY OPTIONS

When you enter the text message, you can change the text entry options by pressing the # key. The current text entry options are displayed in the top bar.

The various text entry options are:

- **For English:**
 - **ABC:** Enter all the text in upper case.
 - **Abc:** Enter the first letter of the sentence in upper case.
 - **abc:** Enter all the text in lower case.
 - **123:** Enter the numbers.
- **For Espanol:**
 - **ES:** Enter all the test in upper case (capitalized).
 - **es:** Enter all the text in lower case.
 - **Es:** Enter the first letter of the sentence in upper case.
 - **123:** Enter the numbers.

TO ENTER A WORD

1. Start by pressing the numeric keys from 2 through 9 only once for the required letter.
 - Ex 1: To enter the word Good, press 4-6-6-3. The word displays on the screen as you type.
 - Ex 2: To enter the word Hello, press 4-3-5-5-6. The word displays on the screen as you type.
2. If the word does not display correctly, press right navigation key to scroll through alternative word choices. Press either the center navigation key or 0 key to accept the word.

TO INSERT A NUMBER

1. Press the key labeled with the number you want and use the navigation key to scroll to that number as above.
2. To insert a symbol, press and hold the numeric key 1 and use the navigation key to scroll and select a symbol.

DIFFERENT METHODS TO ENTER TEXT

- When **English** is selected as input language:
 - **T9ABC**: Enter the text based on the T9 dictionary. All the letters are in upper case (capitalized).
 - **T9Abc**: Enter the text based on the T9 dictionary. Only the first letter of the sentence is in upper case (capitalized).
 - **T9abc**: Enter the text based on the T9 dictionary. All the letters are in lower case.
- When **Espanol** is selected as input language:
 - **T9ES**: Enter the text based on the T9 dictionary. All the letters is in upper case (capitalized).
 - **T9Es**: Enter the text based on the T9 dictionary. Only the first letter of the sentence is in upper case (capitalized).
 - **T9es**: Enter the text based on the T9 dictionary. All the letters are in lower case.
- During text entry mode, when you press/hold **number key 1** to pop-up a special character screen.
- While sending a message, press **# key** to toggle between text entry mode from T9 to ABC.

HOME SCREEN MENU OPTIONS

In order to see the details about any notifications, on the home screen, select **Options key**.

The following options are displayed:

- My Notifications
- Wallpaper
- Search
- Home screen shortcuts
- System settings
- Manage apps

MY NOTIFICATIONS

The left-hand top on your device is where your applications and message services can drop you a note that there is something new to look at, e.g. missed calls, new messages and downloads.

WALLPAPER

You can set an image or a photo stored in your phone as your home screen wallpaper.

To change the wallpaper, select from one of the following **Wallpaper** collections.

From Home screen, press **Options key > Wallpaper**. Select **Wallpapers** from the popup.

- **Gallery:** includes photos and screenshots taken using the phone's camera.
- **Wallpapers:** includes images that are pre-loaded with the phone.

SEARCH

You can search for people, places, music, movies, history and many more. Enter the key word in the search bar and the list is displayed.

HOME SCREEN SHORTCUTS

The navigation **Up**, **Center** and **Down** keys are displayed.

For more information, refer to "HOME SCREEN SHORTCUTS" on page 29.

SYSTEM SETTINGS

System settings refers to the following settings:

- "NETWORK & INTERNET" on page 18
- "SECURITY & LOCATION" on page 26
- "SYSTEM SETTINGS" on page 29

MANAGE APPS

You can manage application and force stop them.

For more information, refer to "APPS & NOTIFICATIONS" on page 22.

QUICK SETTINGS

In order to see the quick settings, on the home screen, select **Left Navigation key**.

You can toggle the **Mobile hotspot** under **Quick Settings**.

MOBILE HOTSPOT

You can enable or disable Mobile hotspot. For more information, refer to “HOTSPOT AND TETHERING” on page 19.

You have the following options under **Quick Toggle**.

WI-FI

You can enable or disable Wi-Fi settings. For more information, refer to “WI-FI” on page 18.

DATA

You can enable or disable Data settings. For more information, “DATA USAGE” on page 19.

BLUETOOTH

You can toggle between **ON** and **OFF**. For more information, refer to “BLUETOOTH” on page 21.

TORCH

You can set the **Torch ON** and **OFF**.

AIRPLANE MODE

Toggle the button to enable or disable the airplane mode. For more information, refer to “AIRPLANE MODE” on page 20.

PROFILES

You can select the profile from the list:

- Standard
- Outdoor
- Silence
- Meeting

For more information, refer to “PROFILE” on page 24.

MISSED EVENTS

To view the missed events, on the home screen, select **Right navigation key**.

Missed events are the missed calls or any events which were saved earlier on the device are listed as missed events.

The missed events can be;



- **Missed calls:** When you miss a call to receive, you get a event notification.
- **Calendar events:** When you have saved an event like birthday, travel etc, and you missed that event on that particular day, a message is displayed in missed events.
- **New messages:** The unread messages are displayed in missed events.
- **Alarm:** A missed alarm is displayed in missed events.
- **New Voicemail:** A new voice mail is displayed in missed events.

NETWORK & INTERNET

WI-FI

Wi-Fi is a wireless network technology that can provide internet access at distance up to 100 feet, depending on the Wi-Fi router and surroundings.

You can access internet when you connect your XP5s to a Wi-Fi network. To connect your phone to a Wi-Fi network;

1. From **Home** screen, select **Menu** () > **Settings** () > **Network & Internet** ().
2. Set the **Wi-Fi** to **ON** position.
3. Select **Wi-Fi**.
A list of Wi-Fi access points present within your phone's accessible range are displayed.
4. Select your preferred network. Enter the WEP/WPS/WPA key (if it is a secured network) and select **Connect**. To verify the password before connecting, enable **Show password**.



It is always recommended to make your Wi-Fi network connection secure and also to connect your phone to a secure network.

Select the connected Wi-Fi network and select **Options** () or **center** key. The following options are displayed:

ADD NETWORK

1. In **Wi-Fi** settings screen, select **Options key > Add network**.
2. Enter the following details:
 - Network SSID: The wireless network ID.
 - Security: Set the security type to None, WEP, WPA/WPA2 PSK, 802.1x EAP.
3. Enable **Advanced options** to set the Proxy details and IP settings.
4. Select **Save** to save the network settings.

CONNECT TO A NETWORK

1. Press center key on any of the listed network.
2. Enter the password on the prompted window and get connected to the network.

EDIT A NETWORK

1. Press and hold the connected network.
2. Select **Modify network**. You can change the network password. The other network setting

details such as **Advanced options**, **Proxy**, **IP settings** can be updated.

3. Select **Save** to save the changes.

FORGET A NETWORK

1. Press and hold the connected network.
2. Select **Forget network**.
The selected network gets disconnected and displayed in the Wi-Fi list.

If you have to get connected to the same network, enter password.

SCANNING SETTINGS

The following options are displayed:

- **Wi-Fi scanning:** Turn **ON** this option to improve location services by allowing the system apps and services to detect Wi-Fi networks at any time.
- **Bluetooth scanning:** Turn **ON** this option to improve location services by allowing the system apps and services to detect Bluetooth devices at any time.

WI-FI PREFERENCES

- **Open network notification:** Enable this option get a notification when a high-quality public network is available.
- **Advanced:** The following options are displayed:
 - **Switch to mobile data automatically:** Enable this option to use mobile data when Wi-Fi has no internet access. Data usage charges may apply.
 - **Install certificates:** You can browse a certificate for installation.
 - **Network rating provider:** By default, this option is greyed out.
 - **Wi-Fi Power Configuration:** You have the option **Keep Wi-Fi on during sleep**. The following options are displayed: **Always (Increases battery consumption)**, **Only when plugged in** and **Never (Increases data usage)**. Select the desired option.
 - **Wi-Fi Direct:** Select **Option key > Searching...** to search for the peer devices and also select **Rename device** to rename the device.
 - **WPS Push Button:** Press **WPS Push Button** in your router, when prompted.
 - **WPS Pin Entry:** Enter the given PIN number on your Wi-Fi router.
 - **MAC address:** A MAC (Media Access Control) address is displayed.





- **IP address:** IP (Internet Protocol) address is displayed.

SAVED NETWORKS

The Wi-Fi networks saved in your device are displayed. You can also add a new Wi-Fi network using **Add network** (+).

MOBILE NETWORK





You can view and set your mobile service provider settings.

1. From **Home** screen, select **Menu** () > **Settings** () > **Network & Internet** ().
2. Select **Mobile network** ().
3. **Mobile data:** Turn **ON Mobile data** to access data using mobile network.
4. **Data roaming:** Turn **ON** this option to get connected to the data services when roaming.
5. **Data usage:** The data usage refers to the amount of data utilized by your phone during data transfers through internet. The data usage charges are dependent of the wireless plan provided by your service provider.
6. **Preferred network type:** The preferred network type is **LTE/UMTS/GSM**.
7. Under **Network**, the following options are displayed:
 - **Automatically select network:** Turn **ON** this option to automatically connect to the network.
 - **Network:** Your service provider network name is displayed and this is disabled.
 - **Access Point Names:** You can view the access points related to your SIM provider.

DATA USAGE

Data usage refers to the amount of data utilized by your phone during data transfers through the internet. The data usage charges are dependent of the wireless plan provided by your service provider.

To monitor your data usage, adjust your data usage settings.





1. From **Home** screen, select **Menu** () > **Settings** () > **Network & Internet** ().
2. Select **Networks & Internet** > **Data usage** ().
3. Press **Option key** > **Mobile networks** to access **Standard data** option. For more information, refer to “MOBILE NETWORKS” on page 19.
4. **Usage:** You can see the details about the data

usage for a particular time frame.

- **Data saver:** Enable **Data saver** to reduce data usage. Data Saver prevents some apps from sending or receiving data in the background.
5. The following options are present in **Mobile**.
 - **Mobile data:** You can turn **ON/OFF mobile data**.
 - **Mobile data usage:** Displays the data usage for a particular time frame.
 - **Billing cycle:** Billing of the used data is displayed here.
 - You can enable the **Set data warning** to get the warning message when your data usage is crossed the preset limits.
 - **Data warning** shows the data available for a particular time frame.
 - Enable **Set data limit** to set the data usage limit.
 6. Select **Wi-Fi** > **Wi-Fi data usage**. When Wi-Fi is enabled, it shows the data used for a particular time frame.
 - **Network restrictions:** The background data is restricted for these networks. While downloading apps, you receive a warning message for these restricted networks.





HOTSPOT AND TETHERING

You can use hotspot and tethering to provide internet to other devices through your mobile data connection. You can share mobile data connection via USB/mobile hotspot/Bluetooth.





1. From **Home** screen, select **Menu** () > **Settings** () > **Network & Internet** ().
2. Select **Hotspot & tethering** ().
3. Enable **USB tethering**. This is enabled only when USB is connected to the device.
4. **Mobile hotspot:** Select **Mobile hotspot** and turn **ON Mobile hotspot**. The following options are displayed:
 - **Set up Mobile hotspot:** You can set up mobile hotspot by entering the following details:
 - **Network name:** Enter the network name.
 - **Security:** Select from the drop-down list.
 - **Password:** The password must have at least 8 characters.
 - Select AP Band: Select either **2.4 GHz Band** or **5 GHz Band**.
 - Select **SAVE** to save the hotspot.
 - **Maximum Connections:** You can connect maximum of 10 devices to the hotspot.
 - **Timeout settings:** You have the following options:
 - Always
 - Turn off when idle for 5 min

- Turn off when idle for 10 min
 - Under **CONNECTED DEVICES**, devices which are connected to the mobile hotspot are listed.
- Bluetooth tethering:** Turn ON this option. When you activate Bluetooth tethering, you can share your phone's internet connection with other Bluetooth paired devices.

VPN



- From **Home** screen, select **Menu** () > **Settings** () > **Network & Internet** ().
- Select **VPN** ().
- Select **Options** () key > **Add VPN profile**.
Before adding the VPN profile, you need to set a lock screen PIN or password.
- In **Edit VPN profile** screen, enter the **Name, Type** (select from the drop-down list) and the **server address**.
- Enter **Username** and **password**.
- Select **Save**.

ETHERNET

- From **Home** screen, select **Menu** () > **Settings** () > **Network & Internet** ().
- Select **Ethernet** ().
- Turn **ON Use Static IP** to enable the following options:
 - IP address
 - Netmask
 - Gateway
 - DNS1
 - DNS2
 - MAC address
- Select **Options** () key and the following options are displayed:
 - Connect
 - Cancel

AIRPLANE MODE





When your phone is set in airplane mode, network connectivity or mobile data connectivity is disabled. But you can access your camera, media files and other features that do not require mobile connectivity.

- From Home screen, select **Menu** () > **Settings** () > **Network & Internet** ().
- Select **Airplane mode** ().
Your device is set on airplane mode.



ADVANCED CALLING

Wi-Fi calling is a service for phones providing the ability to make and receive phone calls over a Wi-Fi connection. It is simple to use with no separate application or log-in required.

- Initially when the phone is switched ON, Wi-Fi calling has to be updated with the emergency address and other information, and the same has to be saved.
- To enable Wi-Fi calling, initially Wi-Fi should be enabled or else a message pops-up to enable Wi-Fi.
- If Wi-Fi setup is not completed, a message is displayed as Wi-Fi Calling Activation; Setup was not completed under My Notifications with the icon ().

- From **Home** screen, select **Menu** () > **Settings** () > **Network & Internet** ().
- Select **Advanced Calling** ().
- Under **Advanced Calling**, you have **Wi-Fi Calling**. When Wi-Fi calling is ON, your phone can route calls through Wi-Fi network or your carrier network, depending on the signal strength and your preferences.

RESET NETWORK SETTINGS

- From **Home** screen, select **Menu** () > **Settings** () > **Network & Internet** ().
- Select **Reset network settings**.
 - It resets all the network settings including Wi-Fi, Mobile data and Bluetooth.





CONNECTED DEVICES

BLUETOOTH

Bluetooth is a short-range wireless communication technology used to communicate between the devices over a distance of about 8 meters.

You can perform the following tasks using Bluetooth paired devices.

- Transfer media files and contacts between connected mobile devices using Bluetooth.
- Use Bluetooth connected headphones for playing media file.
- Bluetooth headset can be used during call.

1. From **Home** screen, select **Menu** () > **Settings** () > **Connected devices** ().
2. On the **Bluetooth** screen, select **Options key** () and the following options are displayed:

SCANNING SETTINGS

- **Wi-Fi scanning:** Turn **ON** this option to improve location services by allowing the system apps and services to detect Wi-Fi networks at any time.
- **Bluetooth scanning:** Turn **ON** this option to improve location services by allowing the system apps and services to detect Bluetooth devices at any time.

RENAME THIS DEVICE

1. Select the Device name.
2. Rename the device screen is displayed.
3. Enter the desired name and select **RENAME**.

PAIR NEW DEVICE

To activate Bluetooth and pair your XP5s device with other Bluetooth devices.

A list of accessible Bluetooth devices are displayed. Ensure that Bluetooth is activated on the other device too.

1. Select **Pair new device** to pair a new device. Available devices are listed.
2. Select the desired device from the list. It will start pairing with the selected device. A confirmation message is displayed to pair the device. Select **PAIR**.

RECEIVED FILES





- Select **Received files** to view the files received via Bluetooth from different devices.

XP5s Bluetooth Supporting Formats

- Bluetooth Keyboards
- PAN Profile
- Supports Modem via Bluetooth connection
- Supports transferring of audio, video, pictures, other files from Bluetooth enabled computers.
- Supports Phonebook sync
- Supports Discovery mode
- Supports Passkey pairing and depends on the Bluetooth peripherals.





USB

USB is a plug-and-play interface that allows a computer to communicate with peripheral and other devices.





1. From **Home** screen, select **Menu** () > **Settings** () > **Connected devices** ().
2. Select **USB** ().
3. You can use USB for the following functions:
 - **Charge the device:** Select this option to use the USB connection for charging the device.
 - **Supply power:** Select this option to charge the connected device. This option works only with the devices that support USB charging.
 - **Transfer files:** When USB is connected and this option is selected, you can transfer the data from one device to another device.
 - **Transfer photos (PTP):** Select this option to transfer photos using USB connection.
 - **Use device as MIDI:** Select this option to interconnect the device with musical instruments.
 - **System update:** Select this option to update the system if there is any update.

APPS & NOTIFICATIONS



APPS INFO

1. From **Home** screen, select **Menu** () > **Settings** () > **Apps & notifications** ().
2. Select **Apps info**.
The list of apps installed on the device are displayed.
3. You can search the desired app using the **Search** tab.
4. Select **Options key** () and the following options are displayed:
 - **Show system:** System based apps are displayed.
 - **Reset app preferences:** You can reset all preferences you set for the apps.

NOTIFICATION

1. From **Home** screen, select **Menu** () > **Settings** () > **Apps & Notifications** ().
2. Select **Notification**.
3. Select **App notifications**. Select the drop-down list. The following options are displayed:
 - All apps
 - Apps: Turned off
4. Select **Notification volume**. You can adjust the notification volume as per your desired level.
5. Select **Default notification sound**. Select the desired ringtone from the list. You can also add a new ringtone using **Add ringtone** ().
6. Enable **Notification blink light**.
Enable/disable the notification glow light toggle based on whether you want to allow the notification pop-up on screen for a particular app.
7. **Flash notification alert:** Turn **ON** this option, When battery is above 20% level, use flash light for missed events.
8. **Flash call alert:** Turn **ON** this option to use flash light for incoming voice call.

APP PERMISSIONS

1. From **Home** screen, select **Menu** () > **Settings** () > **Apps & Notifications** ().
2. Select **App permissions**.
App permissions govern what your app is allowed to do and access.



WIRELESS EMERGENCY ALERTS

From **Home** screen, select **Menu** () > **Settings** () > **Apps & Notifications** ().

- **Alerts:**
 - **Presidential alerts:** These alerts mandatory and always turned **ON**. This is an emergency alert system which allows the US president to address the country in the event of national emergency.
 - **AMBER alerts:** Enable this option to get the child abduction and emergency bulletins.
 - **Extreme threats:** Enable this option to get the extreme threat alerts to life and property. For example; Tsunami, Tornado, Extreme wind, Hurricane and Typhoon warnings.
 - **Severe threats:** Enable this option to get the severe threat alerts to life and property. For example; Storm surge, Flash flood and Dust storm warnings.
- **Area update broadcast:** Shows update information in SIM status.
- **Emergency alert history:** If you have any active emergency alerts, it is displayed in alert history.
- **Alert Preferences:**
 - **Vibrate:** Enable this option to set the device on vibrate during alert.
 - **Alert Reminder Sound:** You can set the following time duration for alert reminder sound: **Once**, **Every 2 minutes**, **Every 15 minutes** and **Off**.

BATTERY SETTINGS

BATTERY





1. From **Home** screen, select **Menu** () > **Settings** () > **Battery** ().
2. Set the **Battery saver** to **ON** by selecting the option given to turn on automatically. You have three options to set the battery saver:
 - Never
 - at 5% battery
 - at 15% battery
3. Turn **ON** the **Battery blink light**. When this option is turned **ON**, light blinks while charging.
4. Select the Battery icon to view the **Advanced battery usage**. You can view the **Battery usage** and **Breakdown since last full charge** options are displayed.
5. In **Last full charge**, it shows when the battery is fully charged.
6. The **Screen usage** duration is displayed.
7. **USB Power Saving**:
 - **Automatic power ON**: If enabled, the device gets automatically powered **ON** when the USB is connected at set time.
 - **Automatic power OFF**:
 - **Automatic power OFF**: If enabled, the device gets automatically powered **OFF** at the set time.
 - **Power off device at**: You can set the time to power off the device.
 - **Automatic power OFF**: If enabled, the device gets automatically powered **OFF** when the USB is disconnected at the set time.
 - **On USB disconnect, power OFF**: You can set the time to power off the device when USB is disconnected.
 - **Sleep**: Set the sleep time so that the screen brightness is turned down after specified time of phone inactivity. This setting also optimizes the battery power. The following are the options: **15 seconds, 30 seconds, 1 minute, 2 minutes, 5 minutes, 10 minutes, 30 minutes, 4 hours** and **8 hours**
8. **App usage since full charge**: you can view the different applications usage after the battery is fully charged.



Battery usage data is approximate and can change based on usage.

DISPLAY SETTINGS

DISPLAY

1. From **Home** screen, select **Menu** () > **Settings** () > **Display** ().
2. Set one of the following options to configure your phone's display:
 - **Brightness level**: Set the brightness of the phone display. This also optimizes the battery power
 - **Wallpaper**: Set the wallpaper for your home screen. You can select from one of the following wallpaper collections:
 - **Gallery** (): includes photos and screenshots taken **using the phone's camera**.
 - **Wallpapers** (): includes images that are pre-loaded with the phone.
3. Select **Sleep**. Set the sleep time so that the screen brightness is turned down after specified time of phone inactivity. This setting also optimizes the battery power. The following are the options: **15 seconds, 30 seconds, 1 minute, 2 minutes, 5 minutes, 10 minutes, 30 minutes, 4 hours** and **8 hours**
4. Select **Font size**. Set font size of the text to be displayed on the screen in the following sizes:
 - Small
 - Default
 - Large
 - LargestYou can use **Up/Down navigation keys** to scroll and **Left/Right** navigation keys to change the size and view the preview.

SOUND SETTINGS

From **Home** screen, select **Menu** () > **Settings** () > **Sound** ().

PROFILE

1. Select **Sound > Profile** and the following options are displayed:

OPTION	DESCRIPTION
1. Standard	Set to Standard and select Option key > Edit . The following options are displayed:
Sound	<ul style="list-style-type: none"> You can set Media volume, Alarm volume, Ring volume, Notification volume, Phone ringtone and Default notification sound. You can enable the Vibrate when ringing.
Other Sounds	You can set Screen locking sounds, Charging sounds and key press tones .
Notification	<ul style="list-style-type: none"> If Notification blink light is enabled, battery status indication is not affected. If Flash notification alert is enabled, when battery is above 20% level, you can use camera flash light for missed events. If Flash call alert is enabled, you can use Flash camera light for incoming voice call.
2. Outdoor	Set to Outdoor and select Option key > Edit . The following options are displayed:



OPTION	DESCRIPTION
Sound	<ul style="list-style-type: none"> You can set Media volume, Alarm volume, Ring volume, Notification volume, Phone ringtone and Default notification sound. You can enable the Vibrate when ringing.
Other Sounds	You can set Screen locking sounds, Charging sounds and key press tones .
Notification	<ul style="list-style-type: none"> If Notification blink light is enabled, battery status indication is not affected. If Flash notification alert is enabled, when battery is above 20% level, you can use camera flash light for missed events. If Flash call alert is enabled, you can use Flash camera light for incoming voice call.
3. Silence	Set to Silence and select Option key > Edit . The following options are displayed:
Sound	When set to Silence mode, this profile blocks all sounds and vibrations including alarms, videos and games. You will be able to make phone calls.

OPTION	DESCRIPTION
Notification	<ul style="list-style-type: none"> • If Notification blink light is enabled, battery status indication is not affected. • If Flash notification alert is enabled, when battery is above 20% level, you can use camera flash light for missed events. • If Flash call alert is enabled, you can use Flash camera light for incoming voice call.
4. Meeting	<p>Set to Meeting and select Option key > Edit.</p> <p>The following options are displayed:</p>
Sound	You can set Media volume, and Alarm volume.





Apart from default profiles, user can create customized profiles.

To create a new profile,

1. From **Home** screen, select **Menu** () > **Settings** () > **Sound** ().
2. Select **Profiles > Option key > Create new**.
3. Enter the required **profile name**.
Maximum length of 24 characters is allowed for the profile name and the name should be unique.
4. After modifying the necessary sound and notification settings, save the new profile.

QUICK PROFILE SWITCH

1. From **Home** screen, select **Menu** () > **Settings** () > **Sound > Profile**.
2. Select **Quick Profile Switch**.
You can use this option to quickly switch profiles via home screen shortcut and Speaker key.

SOUND

- **Media Volume:** You can increase, decrease, and mute media volume.
- **Alarm volume:** You can increase, decrease or mute the alarm volume.
- **Ring volume:** You can change the ringer volume to no ringer or ringing.
- **Notification volume:** You can change the notification volume to no ringer or ringing.
- **Also vibrate for calls:** Enable this option to set the device on vibration for calls.
- **Phone ringtone:** You can select the required ringtone from the list.
- **Default notification sound:** Set the default notification sound from the list.

OTHER SOUND

- **Screen locking sounds:** Enable or disable this option.
- **Charging sounds:** Enable or disable this option.
- **Key press tones:** Enable or disable this option.

NOTIFICATION





- **Notification blink light:** If notification blink light is enabled, this is used to display notification alert and the battery status indication is not affected.
- **Flash notification alert:** If flash notification alert is enabled, when battery is above 20% level, you can use camera flash light for missed events.
- **Flash call alert:** If flash call alert is enabled, you can use Flash camera light for incoming voice call.
- **Wireless Emergency Alerts:** For more information, refer to **“WIRELESS EMERGENCY ALERTS” ON PAGE 22**.

VOICE NOISE CANCELLATION

By default, FENS is enabled and reduces the noise cancellation.

STORAGE SETTINGS





STORAGE

1. From **Home** screen, select **Menu** () > **Settings** () > **Storage** ().
2. On **Internal shared** storage, the following options are displayed with memory used for each app:
 - Photos and videos
 - Music and audio
 - Other apps
 - Files
 - System
3. Select **Options key** () > **Free up space** to free the space from the storage.

SECURITY & LOCATION

DEVICE SECURITY

You can activate and protect your phone from unauthorized access by configuring the security settings.

1. From **Home** screen, select **Menu** () > **Settings** () > **Security & location** ().
The following options are displayed under **Device Security**.
2. Select **Screen lock** and select one of the following options to configure the phone:
 - None
 - Press and hold () key
 - PIN: When enabled, enter your own PIN value.
When the phone is locked, unlock it using the PIN.
When the phone is locked, you can answer an incoming call without unlocking the phone.
3. Select **Owner info**. This option is enabled when any of the screen lock is set. Enter the desired owner's info and select **Save**.
4. **Emergency Info**: You can enter the emergency information to be viewed during an emergency. **My information** screen is displayed. Enter the following details:
 - First name, Last name, Phone number, Email address, Address, Blood type, Allergies, Medication and Organ donorIf you do not want to enter any of the above details, select **Skip**.



Go to **Add** and you can select the contact from the phonebook by selecting **Select contact**.

OR

Select **Add** > **Add new**. Add **First name**, **Last name**, and **Phone number**. Select **Add**.

- This contact is added under Emergency contacts list.

PRIVACY



1. From **Home** screen, select **Menu** () > **Settings** () > **Security & location** ().
2. **Location**: Set the **Location** to **ON** status. **Mode** option is enabled. Select any one the following options:
 - **High accuracy**: uses AGPS, Wi-Fi, mobile networks, and other sensors to get the highest accuracy location for your device. It uses location help to estimate your location faster and more

- accurately.
- **Battery saving:** allows your device to estimate your location using low battery-intensive location sources, such as Wi-Fi and mobile networks. It uses location help to estimate your location faster and more accurately.
 - **Device only:** allows your device to estimate your location using GPS only. It uses the satellite information to provide location information. This mode may use more battery power and take longer time to determine your location.
3. **App-level permissions:** You can set the permission to the desired apps.
 4. Select **Scanning**. The following options are displayed:
 - Enable **Wi-Fi scanning** to improve location by allowing system apps and services to detect Wi-Fi networks at any time.
 - Enable **Bluetooth scanning** to improve location by allowing system apps and services to detect Bluetooth devices at any time.
 - **Recent location requests:** You can also view the apps which have requested location recently under **Recent location requests**.
 5. **Show passwords:** Enable this option to display the password characters as you type in.
 6. **Device admin apps:** Select the apps and activate the device admin apps.
 7. **Manage device info:** To provide access to work data, your organization may change settings and install software on your device.
 8. **SIM card lock:** You can activate and set a SIM lock to lock your SIM, whenever you power ON the phone.
 - Enable **Lock SIM card**. To disable this option, you must enter you SIM lock PIN.
 - Select **Change SIM PIN**. Enter the old PIN and select **OK**. Enter the new PIN and re-enter the same PIN number when asked. Select **OK**.
 9. **Encryption & credentials:**
 - **Encryption:** You can encrypt your phone settings, download applications, contacts, message data and media files.
 - By default, the phone is encrypted.
 - **Credential storage:**
 - **Storage type:** Displays the storage type.
 - **Trusted credentials:** You can view and verify the system and user certificates.
 - **Install from SD card:** You can view and install new user certificates from SD card.
 - **Clear credentials:** You can remove all certificates.
 10. **Trust agents:** To use this option, a screen lock should be set.
 11. **Apps with usage access:** Select the app and select center key to enable the Permit usage access.
 - Select **Options key** (⋮) and the following options are displayed: **Show system** and **Hide system**

ACCESSIBILITY SETTINGS

ACCESSIBILITY

You can make websites and applications more accessible to people with disabilities when they are using mobile phones and other devices.

1. From **Home** screen, select **Menu** () > **Settings** () > **Accessibility** ().
2. Select **RTT (Real Time Text) Visibility**. RTT lets you use the keypad to type messages back and forth during a call. You can select any of the following option:
 - Only during a call
 - During and when placing/receiving a call
3. Select **Volume key shortcut**. You can toggle to **On** and **Off**.
 - If you turn **On**, shortcut service to **Talkback** is enabled.
 - If you turn **Off**, the shortcut service is not available
 - Turn On/Off **Allow from lock screen**.
When shortcut is on, you can press both volume keys for 3 seconds to start an accessibility feature.

SCREEN READERS

- **Talkback:** When Talkback is enabled, it helps vision-impaired users interact with their devices. It uses spoken word, vibration and other audible feedback to let you know what is on your screen.
- **Text-to-speech output:**
 - **Preferred engine:** The preferred engine is set.
 - **Language:** You can select the desired language to adjust the spoken language. System language is set as default language.
 - **Speech rate:** You can move the speech rate using the slider to adjust how faster or slower the text will be spoken.
 - **Pitch:** You can move the pitch value using the slider to adjust how high or low the text will be spoken.
 - **Reset speech rate:** Reset the speech at which the text is spoken to normal.
 - **Reset speech pitch:** Reset the pitch at which the text is spoken to default.
 - **Listen to an example:** Play a short demonstration of speech synthesis.





DISPLAY

- **Font size:** You can set the font size from smaller to bigger and see the preview of the same.
- **Mono Audio:** Enable **Mono audio** to combine the channels when playing audio.
- **Sound balance:** You can move the cursor to the left or right to balance the sound.
- **Vibrate on keypress:** You can enable/disable this option to make the device on vibrate when a key is pressed.
- **Captions:** When Captions is set to **ON**, you can set the following options under **Standard options**:
 - Language
 - Text size
 - Caption styleAll the menu items and user feedback messages will get displayed in the set language.

SYSTEM SETTINGS





HOME SCREEN SHORTCUTS

You can set the shortcuts on the home screen.





1. From **Home** screen, select **Menu** () > **Settings** () > **System** ().
2. Select **Home screen shortcuts** ().
3. Go to the **Navigation up key** and select the app to be set for the up key navigation.
4. Go to the **Navigation center key** and select the app to be set for the center key navigation.
5. Go to the **Navigation down key** and select the app to be set for the down key navigation.

PROGRAMMABLE KEY

You can assign any application to the programmable key.





1. From **Home** screen, select **Menu** () > **Settings** () > **System** ().
2. Select **Programmable key** ().

ACCESSORIES

1. From **Home** screen, select **Menu** () > **Settings** () > **System** ().
2. Select **Accessories** () > **CSM Settings**.
3. Turn **ON CSM settings** to select any application to get CSM settings.
4. You can register CSM application and the same is displayed in **Registered CSM applications**.





LANGUAGES & INPUT

You can set the phone's language to any of the languages displayed in the language list.

1. From **Home** screen, select **Menu** () > **Settings** () > **System** ().
2. Select **Languages & input** ().
3. Go to **Languages** and select any language from the list as your preferred language.
The following languages can be set as a preferred language:
 - English
 - EspañolAll the menu items and user feedback messages will be displayed in the set language.





4. Select **Keyboard & input methods** > **FlexT9 Text Input**.
 - **Input language:** You can set the input language to either **English** or **Español**.
 - **Personal Dictionary:** You can add the desired custom words to the dictionary. Select **Options key** > **Add** to add a word and its shortcut.
 - **Preferences:**
 - **Auto-capitalization:** The first letter of the new sentence is automatically capitalized.
 - **Auto-punctuation:** If this option is enabled, when you press the space key twice at the end of a word, a period will be inserted.
 - **Language switch key:** Press and hold the () key to switch the language.
 - **Next Word Prediction:** Predicts a new word based on the previous word entered.
 - **Suggest contact names:** Displays suggested contact while typing.
5. Select **Support** > **FlexT9 Help**. The FlexT9 help guide is displayed.
Select **Support** > **About**. It displays the FlexT9 version details.
6. Select **Advanced** > **Speech** > **Text-to-speech output**. The following options are displayed:
 - **Preferred engine:** The preferred engine is set.
 - **Language:** By default, **Use system language** is selected.
 - **Speech rate:** You can set the speech rate at your desired level.
 - **Pitch:** You can set the pitch at your desired level.
 - **Reset speech rate:** Reset the speed at which the text is spoken to normal.
 - **Reset speech pitch:** Reset the pitch at which the text is spoken to default.
 - **Listen to an example:** Play a short demonstration of speech synthesis.

GESTURES





1. From **Home** screen, select **Menu** () > **Settings** () > **System** ().
2. Select **Gestures** ().
3. Turn **ON Toggle Torch**.
You can quickly toggle the torch by shaking the device twice.

DATE & TIME





You can set and display the date and time on the phone.
You can also select the display format.

1. From **Home** screen, select **Menu** () > **Settings** () > **System** ().
2. Select **Date & time** ().
3. Select the following options to configure phone:
 - To synchronize the date and time with the network provided time, enable **Automatic date & time**. Disable **Automatic date & time** to enable **Set date** and **Set time** options.
 - To synchronize the time zone with the network provided time enable, **Automatic time zone**. Disable **Automatic time zone** to enable **Select time zone**.
 - To set the date manually, select **Set date**. Scroll and select the date, month and year. Select **Done**.
 - To set the time manually, select **Set time**. Scroll and select the hour and minute. Select **Done**.
 - To set the time zone, select **time zone**. Scroll and select your time zone.
 - To set the clock to 24-hour format enable **Use 24-hour format**. By default, the phone is set to **12-hour format**.



RESET OPTIONS

1. From **Home** screen, select **Menu** () > **Settings** () > **System** ().
2. Select **Reset options** ().
3. You can reset the following settings:
 - Reset Wi-Fi, mobile & Bluetooth
 - Reset app preferences
 - Erase all data (factory reset)

ABOUT PHONE

1. From **Home** screen, select **Menu** () > **Settings** () > **System** ().
2. Select **About phone** ().
3. The following information is displayed:
 - Status
 - Legal Information
 - Model
 - Firmware version
 - Firmware security patch level
 - Baseband version
 - Kernel version
 - Build number

SYSTEM UPDATES

1. From **Home** screen, select **Menu** () > **Settings** () > **System Updates** ().
2. The following options are displayed:
 - Check for new system updates
 - Show system update history
 - Use Software Upgrade Assistant
 - System Update Status

MANAGING CONTACTS

You can use the phonebook to maintain phone numbers of your contacts. This feature enables you to add, dial phone numbers and send SMS and MMS messages.

To access the contacts, from **Home** screen, select **Contacts** (👤). The contacts saved in the phonebook are displayed.

ADDING NEW CONTACT FOR THE FIRST TIME

After inserting the SIM, when you switch **ON** the device for the first time and there are no contacts added in the device or SIM, you have only the following two options:

- **Add Contact:** **Add New contact** screen is displayed. Enter all the details and select **Options key > Save** to save the contact.
- **Import Contacts:** Select **Import Contact** to import from .vcf file.

ADDING A NEW CONTACT

1. From **Home** screen, select **Menu** (☰) > **Contacts** (👤).
2. To add a new contact, select **Menu > Contacts > Option key > Add contact**. Enter the contact details and select **Option key > Save** to save the contact.
3. You can also enter a number using dialpad and select **Add to contact** (👤) and then **Create new contact** (👤) to add a new contact. Select **Option key > Save** to save the contact.

VIEWING CONTACT DETAILS

1. From **Home** screen, select **Menu** (☰) > **Contacts** (👤).
2. Scroll to the required contact and select the contact to view the contact details.

SENDING A MESSAGE FROM CONTACTS

You can send SMS and MMS messages to the contacts.

1. From **Home** screen, select **Menu** (☰) > **Contacts** (👤).
2. Scroll to the required contact and open it.

3. Select **Option key > Send message**.
4. Enter the message and select **Option key > Attach photos/videos** to attach the photos and videos.
5. Select **Option key > Send**.



If you attach a media file or a contact to your SMS message it is converted to an MMS message automatically.

DIALING A NUMBER FROM CONTACTS

1. From **Home** screen, select **Menu** (☰) > **Contacts** (👤).
2. Scroll to the required contact and select the contact to view the details.
3. Select the number and press **Center** key to initiate the call. **OR**
4. Select the required contact from the list and press the green button on the phone to initiate the call.

EDITING THE CONTACT DETAILS

1. From **Home** screen, select **Contacts** (👤).
2. Scroll to the required contact and select the contact to view the details.
3. Select **Option key > Edit**.
4. Edit the required details. Select **Option key > Save** to save the details.

MENU OPTIONS

On the **Contacts** screen, select **Options key** to view the menu options. Following are the menu options:

MY INFO:

1. Select **My Info** and a screen is displayed to add device owner's name, Phone number and an email id. Select **Option key > Save** to save the contact details.



If contact details of **ME** are not saved, the **Menu** options are not displayed.

- Select **Option key** and you have the following options:
 - **Send message:** You can select either email or the phone number to send a message.
 - **Edit:** You can edit the contact details.
 - **Share:** You can share your contact details via **Messaging** and **Bluetooth**. The contact is shared as .vcf file.



- **Send Contact:** The contact is sent as a text message to the selected contact.

ADD CONTACT

You can add a new contact by entering all the details. Select **Options key** > **Save** to save the contact.

IMPORT/EXPORT



IMPORT FROM .VCF FILE

1. From **Home** screen, select **Menu** () > **Contacts** ().
2. Select **Option key** > **Import/export**.
3. Select **Import from .vcf file**.
4. Press **Center** key to select the .vcf file to be imported.
5. Select **OK**.
The contact is imported to the list.





If the device has only one vcf file, it is imported without any selection window.

EXPORT TO .VCF FILE

1. From **Home** screen, select **Menu** () > **Contacts** ().
2. Select **Option key** > **Import/export**.
3. Select **Export to .vcf file**.
4. Press **Center** key to select the contact to be exported.
5. Select **Option key** > **Done**.
A message is displayed for the location, where the .vcf file saved.
6. Select **OK** to confirm.
The .vcf file is exported to the device internal memory.

SHARE ALL CONTACTS

You can send contact information in two different ways:

1. From **Home** screen, select **Menu** () > **Contacts** ().
2. Select **Option key** > **Import/export**.
3. Select **Share all contacts**. You can use one of the following options to share the required contact:
 - **Messaging:** Send the contact details as a multimedia message to any mobile phone.
 - **Bluetooth:** Send the contact details to a Bluetooth device paired with your phone. Select a Bluetooth device to share the contact.

BLOCKED NUMBERS



You cannot receive either a call or a text message from the blocked number.

SELECT

You can select the required contacts by checking the boxes next to the contact.



SETTINGS

You can set the sort list to view the contacts and also the first or last name of the contact to be displayed first.



1. From **Home** screen, select **Menu** () > **Contacts** ().
2. Select **Options key** > **Settings**. Set the following options:
 - **Sort by:** Sort the contact names by first name or last name.
 - **Name format:** Set the contact display name to first name or last name.

MANAGING CONTACT SETTINGS

You can edit and modify ringtone and call receiving settings for individual contacts.

1. From **Home** screen, select **Menu** () > **Contacts** ().
2. Scroll to the required contact and select the contact to view the contact details.
3. Select **Options key** and select one of the following:
 - **Set Ringtone** to set a specific ringtone for that contact.
 - Check the option **All calls to voicemail** to forward all incoming calls from that contact to your voice-mail box.

DELETING A CONTACT

1. From **Home** screen, select **Menu** () > **Contacts** ().
2. Scroll to the required contact and select the contact to view the contact details.
3. Select **Options key** > **Delete** or press **Clear** () key. The contact is deleted after the confirmation.

MANAGING CALL SETTINGS

MAKING A CALL



- Press **Green key** () or select **Menu > Phone** and the **Call history** can be viewed.

The phone screen with last dialed number, missed calls and received calls are displayed.



OR

- From home screen, you can enter the number and initiate a call.



DIALING A NUMBER VIA CONTACT

1. From **Home** screen, select **Menu** () > **Contacts** ().
2. Scroll to the contact and select the contact. The contact details are displayed.
3. Select the required phone number to call the contact.



ADDING A CONTACT FROM HOME SCREEN

1. From **Home** screen, enter the required number to be dialed.
2. Select **Add to contact** ().
3. Select **Create new contact** ().
4. In the **Add new contact** screen, add the name and other details for the contact.
5. Select **Option key > Save**.
The contact is saved.

VIEWING CALL HISTORY

1. Press **Green key** () or from **Home** screen, select **Menu > Phone** ().
2. The **Recent calls** screen displayed with recently called, received, and missed calls.

DELETING CALL HISTORY

1. Press **Green key** () or from **Home** screen, select **Menu > Phone** ().
2. On the **Recent calls** screen, select **Option key > Delete selected call log**.
OR

Press **Clear** () key on the keyboard to delete the selected call log.



3. A confirmation message is displayed to delete the selected call log. Select **Delete** to delete the call

log. The selected call log is deleted.

SPEED DIAL SETTINGS



With this option, the user can assign a contact to each key present in the keypad (2 to 9).

To set the speed dial,

1. Press **Green key** () or from **Home** screen, select **Menu > Phone** ().
2. On Recent calls screen, select **Option key > Speed dial** settings.
3. Assign a contact for each key present in the keypad (2 to 9) and Key 1 is used for voicemail.
4. Long press a particular numeric key to initiate a call to the assigned contact.

CALL SETTINGS

To view and modify call settings,

1. Press **Green key** () or from **Home** screen, select **Menu > Phone** ().
2. On Recent calls screen, select **Option key > Call settings**. Different settings are:

QUICK RESPONSES

When you are not able to answer an incoming call, you can send a quick response to the caller. To view and edit quick responses, select **Call settings > Quick responses**. Select the specific response message to edit. Edit the message and select **OK**.

CALLS

I. Calling Accounts:

SIP SETTINGS

- **SIP Accounts:**

To add a SIP account and configure your incoming and outgoing preferences:

1. In the **Call settings** screen, select **Calling accounts > SIP accounts**.
2. Enable Receive incoming calls to answer incoming internet calls.
This might reduce your phone's battery life.
3. Select **Option key > Add account** to configure a new SIP account.
4. Enter the following details and select **Option key > Save** to save the account:
 - **Username:** Username to login to SIP account.

- **Password:** Password to login to SIP account.
- **Server:** SIP server details.
- **Optional Settings:** Select to view/modify or hide optional details such as authentication username, display name, outbound proxy address, port number, transport type and Send keep alive options.
- **USE SIP CALLING**
 - Select **Calling accounts > Use SIP calling**.
 - A dialog is open with the following options:
 - **For all calls:** If this option is selected and when the phone is connected to Wi-Fi network or mobile internet, each dialed call becomes an internet call.
 - **Only for SIP calls:** If this option is selected, only SIP call can be dialed.
- **RECEIVE INCOMING CALLS**

Enable Receive incoming calls to answer incoming internet calls.

This might reduce your phone's battery life.

II. VOICEMAIL:

- **Service:** Displays the Service name. It is displayed as My carrier.
- **Setup:** You can set a number for voicemail.

CALL BLOCKING

You will not receive calls or messages from the blocked numbers.

ACCESSIBILITY

- **Hearing aids:** Turn **On Hearing aids** to set your device hearing aid compatible.
- **RTT (Real Time Text) Visibility:** RTT lets you use the keypad to type messages back and forth during a call. You can select any of the following option:
 - Only during a call
 - During and when placing/receiving a call

SENDING MESSAGES

SMS and MMS are convenient and inexpensive means of communication. You can send a text message to other people via SMS service. MMS allows you to send messages by including multimedia content such as pictures, audio files, video files, and so on.

You can use the Messaging in your phone to send an SMS and MMS message to other mobile phones or any other equipment that can receive SMS and MMS.

 The MMS feature is available only if you subscribe it from your network operator.

To access the message function, from **Home** screen, select **Messaging** ().

SENDING SMS/MMS MESSAGE

You can send SMS and MMS messages to contacts in your phonebook and to new numbers that are not present in the phonebook.

1. To create a SMS message, from **Home** screen, select **Messaging** ().
2. Select **Option key > New message**.
3. Enter the contact name or the phone number in the **To** field.

If you enter an alphabet, all the contact names starting with that alphabet and containing that alphabet are displayed as a list. Scroll down to select the contact.

4. Enter the message.

When you add an attachment, the message is automatically converted to a multimedia message. MMS charges will apply, based on the operator.



5. You can add any multimedia attachment up to the size of ≤ 1 MB. To add an attachment, select **Options key > Attach photos/videos**. Browse to a specific folder and select the multimedia file to be attached.
6. Select **Option key > Attach others**. Select the attachment type from the options in the next step.

ATTACHMENT TYPE	DESCRIPTION
Capture picture	Take a new photo using the mobile camera and attach.
Capture video	Take a new video using the camcorder and attach.
Audio	Attach an audio file from the phone memory.
Record audio	Record a new audio using the sound recorder and attach.
vCard	Attach a contact available in the phone.
vCalendar	Attach a calendar event.

7. Select **Option key > Add Subject**. You can enter the desired subject.

DELETING MESSAGES

To delete all the messages,

1. From **Home** screen, select **Messaging** ().
2. Select the message and press **Option key > Delete selected thread** or select a message thread and press **Clear key** ().
3. A confirmation message is displayed. Select **Delete** to delete the selected message.
4. To delete an individual conversation, select the conversation to be deleted and select **Delete** option and confirm the choice.

WIRELESS EMERGENCY ALERTS

You will receive active alerts and emergency alerts from the service provider. For more information, refer to “Wireless Emergency Alerts” on page 22.

MANAGING MESSAGE SETTINGS

You can customize the way you want to view and filter the messages.

To view and modify the message settings,

1. To edit message settings, from **Home** screen, select **Messaging** ().
2. Select **Option key > Settings**.
3. View and edit the following settings:

SETTINGS	DESCRIPTION
NOTIFICATION	
Vibrate	Enable vibrate alert for incoming messages.
DISPLAY	
Group notification message	Enable this notification message to auto combine the notification into one group.
STORAGE	
Delete old messages	Delete old messages automatically when the storage limit is reached.
Text message limit	Set the maximum number of SMS messages to be stored.
Multimedia message limit	Set the maximum number of MMS messages to be stored.
Memory status	Shows the memory used for SMS, MMS and the total memory used.
ADVANCED SETTINGS	
Text (SMS) messages settings	
Delivery reports	Enable to request a delivery report for each message you send.
Message template	Edit the quick message template.
SMS Signature	You can enable/disable the signature.
Edit SMS signature	Enable SMS signature to enable this option. You can edit your SMS signature.
Manage SIM card messages	Manages the messages in the SIM card located under Text Messages .

Enable WAP PUSH Service	Enable to receive service message.
Multimedia (MMS) messages settings	
Group messaging	Enable and use MMS to send a single message when there are multiple recipients.
Delivery reports	Enable to request a delivery report for each message you send.
Read reports	Enable to request a read report for each message you send.
Auto-retrieve	Enable to automatically retrieve messages.
Roaming auto-retrieve	Enable to automatically retrieve messages while roaming,

VERIZON SERVICES

Your Sonim phone comes with pre-loaded Verizon PTT applications.

From **Home** screen, select **Menu** () > **Verizon** ().

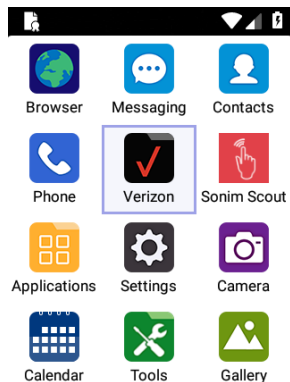



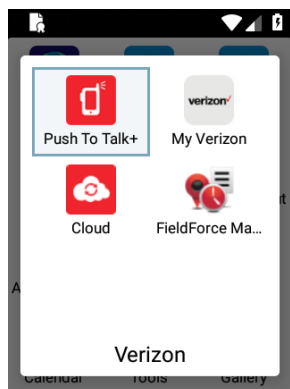

The following screen with different applications is displayed:



- Push To Talk+
- My Verizon
- Cloud
- FieldForce Manager





PUSH TO TALK+

1. From **Home** screen, select **Menu** () > **Verizon** () > **Push To Talk+** ().
2. Scroll down to the end of the page and select **Options key** ().
3. Select **Accept** to activate Verizon Push Talk Plus.
4. In Confirm screen, enter the code in **Enter activation code** field. Select **OK**.



MY VERIZON

1. From **Home** screen, select **Menu** () > **Verizon** () > **My Verizon** ().
2. Enter your **User ID** or **Cell Phone Number**.
3. Select **Sign Me In**.

CLOUD

1. From **Home** screen, select **Menu** () > **Verizon** () > **Cloud** ().
2. Select **Next** on Verizon Cloud screen.

FIELDFORCE MANAGER



1. From **Home** screen, select **Menu** () > **Verizon** () > **FieldForce Manager** ().
2. Select **ALLOW** to allow **FieldForce Manager** to access device's location.
3. Enter your phone number in **Please confirm your phone number** field. Select **Activate**.

SONIM SCOUT

Sonim SCOUT is a solution that allows the user to register with Sonim and use a number of key enterprise features.

Sonim Cloud account required to fully utilize SCOUT capabilities. Visit <http://www.sonimcloud.com> for more information.

To access Sonim Scout,

- From **Home** screen, select **Menu** () > **Sonim Scout** ().

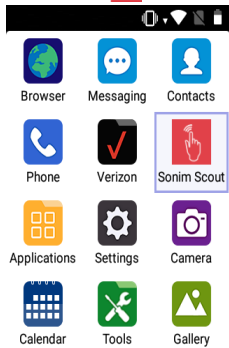

SETUP

Setup tab consists of the following features:

- SonimSetupWizard
- SafeGuard
- App Updater

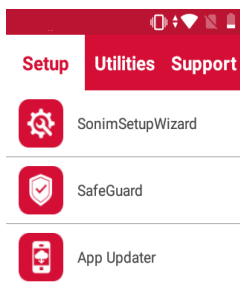

UTILITIES

Utilities tab consists of the following features:

- Contact Transfer
- Sonim BLE Connect

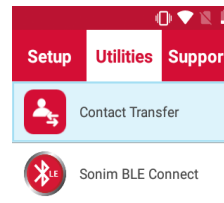

SUPPORT

Support tab consists of the following features:

- Chat
- SonimCare
- Warranty Registratin
- Device Information
- Terms of Use
- Contact Sonim Support
 - Call
 - Email

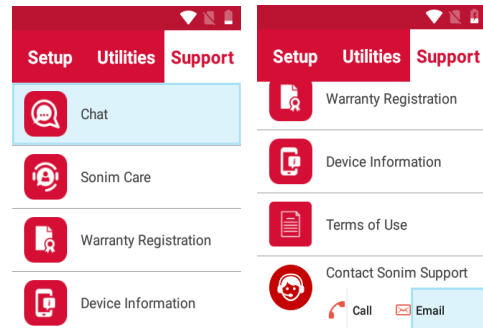

APPLICATIONS

MUSIC



You can play music files and voice memos stored in your phone using the music application.

From **Home** screen, select **Menu** () > **Applications** () > **Music** ().

- Select **Artists** to view the music files sorted based on the artists.
- Select **Albums** to view the music files sorted based on the albums.
- Select **Songs** to view the complete list of songs stored in your phone.
- Select **Playlists** to access the default playlists in the music folder.
 - Select **Recently added** playlist to view the music files that are recently added to the music folder.
 - Select **My recordings** playlist to access all your voice memo files.

FM RADIO

You can listen to the radio through FM radio. A wired Headset should be connected to enable FM radio.

1. To listen to the radio, select **Menu** () > **Applications** () > **FM Radio** ().
 2. A message **Connect Headset** is displayed. Connect a wired Headset with the side connector to enable FM Radio. **FM radio** icon is displayed on the **Notification** bar.
- **Side Connector:** As the Sonim XP5s device does not support the jack, side connector is used to plug-in the jack and listen to FM radio over the headset.



3. Select **Options** > **Radio On** to turn on the radio.
 4. Select **Options** and the following options are displayed:
 - **Auto Scan:**
 - On selecting **Auto Scan** for the first time, the device starts scanning all available stations and a pop-up message is displayed; **Scanning for all stations.**
 - Once the scanning is completed, a confirmation message is displayed on **All Channels** screen; **Scan Complete: Number of channels scanned.**
 - If any channel present in Preset list, select **Auto Scan and a pop-up message** is displayed; **Clear the channels list?** Select **Yes** to scan all available channels.
 - **All Channels:** All scanned channels are listed.
 - **Preset:** Connect to a particular station and select **Options** > **Add to presets.** The selected channel is added to the preset list.
- Select **Preset** > **Options** and the following options are displayed:
- **Rename:** You can rename the channel/station.
 - **Remove from presets:** Selected channel is removed from the preset.
 - **Loud Speaker/Wired Headset:** You can set the radio on loud speaker. When you set the radio on loudspeaker mode, it displays **Wired Headset** as an option.
 - **Sleep:** You can turn off the radio after a selected time frame:
 - 15 minutes
 - 30 minutes
 - 45 minutes
 - 1 Hour
 - **Start Recording:** You can record the audio which is broadcasted on the radio to listen to the same later.
 - **Settings:** The following options are displayed under **Settings:**
 - **Regional Band:** The regional band with frequency range is displayed.
 - **Audio Output Mode:** Select any of the following options as a output mode: **Stereo** or **Mono**
 - **Alternate Frequency:** Check this option enable/disable the auto selection of alternate frequency.
 - **Revert to Factory Defaults:** This option deletes all the settings including Presets. Select **OK** to confirm.
 - **Radio off:** Select this option to turn off the radio.

FILE EXPLORER

You can view/edit/delete/share the files stored in the phone through **File Explorer** ().

To view the files, select **Menu** () > **Applications** () > **File Explorer** ().

Select any file and press **Option key** to view the following options:

- **Recent:** Displays the recent files captured or stored.
 - **Share:** Share the file or file via Messaging/Bluetooth.
 - **Copy to:** Copy the contents of the file.
 - **Properties:** View the properties of the file.
 - **Select:** Select a particular file.
 - **Exit:** You can select **Exit** option for exiting from File Explorer.
- **Downloads:** Displays the different file under Downloads.
 - **Share:** Share the file via Messaging/Bluetooth.
 - **Delete:** Delete the existing file.
 - **Settings:** Different settings are displayed.
 - **Exit:** You can select **Exit** option for exiting from File Explorer.
- **XP5800:** Displays the different file in the device drive.
 - **Search:** Search for the file and file.
 - **Delete:** Delete the existing file.
 - **Copy to:** Copy the contents of the file.
 - **Move to:** Move the contents of file.
 - **Rename:** Rename the existing file.
 - **Properties:** View the properties of the file.
 - **Select:** Select a particular file.
 - **Sort by:** You can sort the file using **Sort** option. Sorting options are; **By Name**, **By Date Modified** and **By Size**.
 - **New folder:** You can create a new file.
 - **Exit:** You can select **Exit** option for exiting from File Explorer.





If SD card is inserted, all the files in the SD card can be view/edit/delete/share from file explorer.

BACKUP AND RESTORE

If you need to replace your device or erase its data, you can restore your data for any accounts that were previously backed up.

To back up your data,

1. From **Home** screen, select **Menu** () > **Applications** ().
2. Select **Backup and Restore** ().
3. Select **Backup**.

All your contacts, Calendar, SMS and MMS data will be backed up and media content like photos, audio and videos are moved to SD card.

A warning message is displayed **Backup may take few minutes. Please do not perform other operations during this time.**

Select **OK** to start the backup.



4. Select **Restore**.
The contacts, Calendar, SMS and MMS are restored.





Without SD card, the user cannot take device back-up.

DOWNLOADS

Use the Downloads screen to view, open, or delete the downloaded files.

1. From **Home** screen, select **Menu** () > **Applications** ().
2. Select **Downloads** ().
3. Select **Options** > **Select** to select the downloaded file to be opened, viewed, or deleted.

VOICE COMMANDS

1. From **Home** screen, select **Menu** () > **Applications** ().
2. Select **Voice Command** ().
3. Different tasks which Voice Command can perform are listed. Speak out the desired command from the list.

CLOCK

You can view the time of major cities in different time zones using this function.

1. From **Home** screen, select **Menu** (☰) > **Tools** (🔧).
2. Select **Clock** (🕒).
3. Select **World clock icon** (🌐) located on the top of the screen. To add a city, select **Option key** > **Select cities**. Select the check boxes next to the cities to add them to the **Clock**.
 - The local time in the home city is displayed in the upper half of the screen.
 - To set the home city, select the required city from the list. It is added to the selected cities list. The selected city is set as the home city.
4. Select **Option key** > **Settings** and the following options are displayed:
 - **Clock:**
 - Style
 - Automatic home clock
 - Home time zone
 - Change Date & time
 - **Alarms:**
 - Silence after
 - Snooze length
 - Alarm volume
 - Gradually increase volume
 - Volume buttons
 - Default alarm tone
 - Start week on
 - **Timers:**
 - Time ringtone
 - Gradually increase volume

ALARM

You can set an alarm for a particular time.

1. From **Home** screen, select **Menu** (☰) > **Tools** (🔧).
2. Select **Clock** (🕒).
3. Select **Alarm** activation icon (🔔) on the top of the screen.
4. Select **Option key** > **Add** to add a new alarm.
5. To set a recurring alarm, select **Option key** > **Edit**. You can choose and set the following options:
 - **Time:** You can set the required time.
 - **Repeat:** You can select the days in a week to repeat the alarm for all the selected days.

- **Alarm Ringtone:** Select the alarm ringtone.
 - **Label:** You can name the alarm.
 - **Vibrate:** Enable this option to set the device on vibrate when the alarm rings.
6. Select any of the ringtones from the **Default alarm tone sound** present, and select **OK**.



The alarm will work even when the phone is set in silent mode.

TIMER

1. From **Home** screen, select **Menu** (☰) > **Tools** (🔧).
2. Select **Clock** (🕒) > **Timer** (⌚).
3. Type any number using the keypad. Select **START** and **PAUSE** to run the timer.
4. The following actions can be performed: **RESET** and **RESUME**

STOPWATCH

1. From **Home** screen, select **Menu** (☰) > **Tools** (🔧).
2. Select **Clock** (🕒) > **Stop watch** (⌚).
3. Select **START** to run the stop watch.
4. You can also perform the following actions:
 - RESET, RESUME, PAUSE and LAP



CALCULATOR

The default calculator in this phone is designed to perform simple mathematical calculations and the advanced panel for scientific calculations.

1. From **Home** screen, select **Menu** (☰) > **Tools** (🔧) > **Calculator** (⊕).
 - To enter the numbers, select the numeric keys.
 - To use mathematical operators, select the respective operation key on the keypad.
 - Select = for the final result.
2. Select **Option key** > **Advanced panel** for scientific calculations. You can toggle between **Basic panel** and **Advanced panel**.

SIM TOOLKIT





It displays the operator specific services. To access the SIM Toolkit,

1. From **Home** screen, select **Menu** () > **Tools** () > **SIM Toolkit** ().
2. It displays the SIM provider and the respective service details.

SOUND RECORDER

You can record voice memos using the sound recorder.





To access the sound recorder,

- From **Home** screen, select **Menu** () > **Tools** () > **Sound Recorder** ().
 - To record an audio file, select **Record** ().
 - To stop the recording, select **Stop** ().
 - To save the voice memo, press left arrow key and select **Save**.
 - To exit without saving, press left arrow key and select **Discard**.
 - To play the recorded file instantly, press right arrow key and select the file to be played. Press **Center** key to play the voice memo.
 - To pause the recording instantly, press the centre key.

OTHER APPLICATIONS

CAMERA



The Sonim XP5s has a rear camera with 5MP fixed focus for taking pictures. The pictures are saved in the **Gallery**.

1. From **Home** screen, select **Menu** () > **Camera** ().
2. Select Camera mode to set the following modes:
 - **Normal** (): To shoot a picture in normal mode, press **center** key to capture the picture. Use Left and Right navigation keys for Zoom in and Zoom out.
 - **Video** (): Press **center** key to start/stop a video recording. You cannot pause the recording in the middle.
3. Select **Option key** () to view or change camera settings such as **Flash**, **Exposure**, and **File Format** etc.

CALENDAR

The Calendar helps you to set appointments, schedule reminders and alerts and repeat them if required. You can also view your saved tasks on a daily or weekly basis.

To access calendar;

1. From **Home** screen, select **Menu** () > **Calendar** ().
 2. To change the calendar view, choose **Month** or **Agenda** from **Options** menu.
 3. Select **Options** key to view the list of the following available options:
 - **Today**: Access current date events.
 - **New event**: New event can be added on selecting this option.
 - **Agenda**: Select each agenda and to view the event details.
 - **Search**: You can search for a particular event.
 - **Delete Events**: Select the **event** > **Option key** > **Done** to delete the selected event. Select **Select all** to delete all the events.When you have an event, the **Delete events** option is enabled.
- **Settings**:
 - Displays the **General settings** of the calendar.
 - Displays the **Build version** in **About Calendar**.



GALLERY

The pictures, videos, and screenshots captured from the camera are stored in **Gallery** and can be viewed later.

From **Home** screen, select **Menu** () > **Gallery** ().

You can view the photo album, screenshots, and the individual pictures.

BROWSER

1. From **Home** screen, select **Menu** () > **Browser** ().
2. Enter the URL to search for the required information or any website.
3. Select **Option key** and you can view the list of options such as;
 - Go to URL
 - Homepage
 - Switch Tabs
 - Refresh
 - Forward
 - Bookmarks
 - Save to bookmarks
 - History
 - Copy URL
 - Share page
 - Find on page
 - Request desktop site
 - Settings
 - Exit

REGULATORY INFORMATION - USA MARKET

RF EXPOSURE INFORMATION (SAR)

This device meets the government's requirements for exposure to radio waves.

This device is designed and manufactured not to exceed the emission limits for exposure to radio frequency (RF) energy set by the Federal Communications Commission of the U.S. Government.

The exposure standard for wireless device employs a unit of measurement known as the Specific Absorption Rate, or SAR. The SAR limit set by the FCC is 1.6W/kg. *Tests for SAR are conducted using standard operating positions accepted by the FCC with the device transmitting at its highest certified power level in all tested frequency bands. Although the SAR is determined at the highest certified power level, the actual SAR level of the device while operating can be well below the maximum value. This is because the device is designed to operate at multiple power levels so as to use only the power required to reach the network. In general, the closer you are to a wireless base station antenna, the lower the power output.

The highest SAR value for the model device XP5800 (Type number PG2112) as reported to the FCC:

- when tested for use at the ear is 0.98W/kg, and
- when worn on the body, as described in this user guide, is 1.35W/kg (Body-worn measurements differ among device models, depending upon available accessories and FCC requirements.)

While there may be differences between the SAR levels of various devices and at various positions, they all meet the government requirement.

The FCC has granted an Equipment Authorization for this model device with all reported SAR levels evaluated as in compliance with the FCC RF exposure guidelines. SAR information on this model device is on file with the FCC and can be found under the Display Grant section of www.fcc.gov/oet/ea/fccid after searching on FCC ID: WYPPG2132.

For body worn operation, this device has been tested and meets the FCC RF exposure guidelines for use with an accessory that contains no metal and be positioned

a minimum of 1.5cm from the body. Use of other accessories may not ensure compliance with FCC RF exposure guidelines. If you do not use a body-worn accessory and are not holding the device at the ear, position the handset a minimum of 1.5cm from your body when the device is switched on.

FEDERAL COMMUNICATION COMMISSION INTERFERENCE STATEMENT

This device complies with part 15 of the FCC Rules. Operation is subject to the following two conditions:

- This device may not cause harmful interference, and
- This device must accept any interference received, including interference that may cause undesired operation.

This device has been tested and found to comply with the limits for a Class B digital device, pursuant to Part 15 of the FCC Rules. These limits are designed to provide reasonable protection against harmful interference in a residential installation. This equipment generates, uses, and can radiate radio frequency energy, and, if not installed and used in accordance with the instructions, may cause harmful interference to radio communications. However, there is no guarantee that interference will not occur in a particular installation. If this equipment does cause harmful interference to radio or television reception, which can be determined by turning the equipment off and on, the user is encouraged to try to correct the interference by one or more of the following measures:

- Reorient or relocate the receiving antenna.
- Increase the separation between the equipment and receiver.
- Connect the equipment into an outlet on a circuit different from that to which the receiver is connected.
- Consult the dealer or an experienced radio/TV technician for help.

FCC CAUTION

- Any Changes or modifications not expressly approved by the party responsible for compliance could void the user's authority to operate the equipment.
- The antenna(s) used for this transmitter must not be co-located or operating in conjunction with any

a minimum of 1.5cm from the body. Use of other accessories may not ensure compliance with FCC RF exposure guidelines. If you do not use a body-worn accessory and are not holding the device at the ear, position the handset a minimum of 1.5cm from your body when the device is switched on.

HAC RATING

The FCC has created a rating system for cellular phones regarding their HAC-related performance. This rating helps consumers with hearing disabilities to find phones that work well with their hearing aid devices. The HAC rating and measurement procedure are described in the American National Standards Institute (ANSI C63.19-2011) contains two rating standards: an “M” rating from 1 to 4 for hearing aids operating in microphone mode, and a “T” rating from 1 to 4 for hearing aids operating in tele coil mode. M-Rating stands for Microphone rating and indicates the amount of reduction of RF interference between the telephone and the hearing aid in acoustic coupling mode (also called microphone mode). Phones rated M3 or M4 meet FCC requirements and generate less interference to hearing devices set in microphone mode. T-Rating stands for tele coil rating and represents inductive coupling with hearing aids that are operating in telecoil mode. A tel coil is a small piece of tightly wrapped wire, built into some hearing aids.

microphone of a hearing aid picks up all sounds, the telecoil only picks up an electromagnetic signal from the telephone. Thus, users of telecoil-equipped hearing aids are able to communicate over the telephone without the amplification of unwanted background noise. Phones rated T3 or T4 meet FCC requirements and generate less interference to hearing devices set in telecoil mode. A combination of M-rating and T-rating defines the final HAC rating and is a deciding factor in selecting cellular phones for people with hearing problems. A HAC compliant phone could be rated:

- M3/T3, M3/T4, M4/T3 and M4/T4

These ratings assist hearing device users to find phones that are compatible with their hearing devices. Ratings are shown on the phone’s box or label. The ratings are not guaranteed for suitability. The results vary depending on the individual’s hearing loss and the immunity characteristics of the used hearing device, i.e. its resistance to interference. The best way to evaluate the suitability of the phone is to try it with the intended hearing aid device.

The model XP5800 have been tested for hearing aid

device compatibility and complies with the Federal Communications Commission (FCC) requirements. These devices are rated M3/T4.

ISED RF EXPOSURE STATEMENT (IC)

This EUT is compliance with SAR for general population/uncontrolled exposure limits in IC RSS-102 and had been tested in accordance with the measurement methods and procedures specified in IEEE 1528 and IEC 62209. This equipment should be installed and operated with minimum distance 1.5 cm between the radiator and your body. This device and its antenna(s) must not be co-located or operating in conjunction with any other antenna or transmitter.

END USER LICENSE AGREEMENT(EULA)

This wireless device, (the “Device”) contains software owned by Sonim Technologies, Inc. (“Sonim”) and its third party suppliers and licensors (collectively, the “Software”). As user of this Device, Sonim grants you a non-exclusive, non-transferable, non-assignable license to use the software solely in conjunction with the Device on which it is installed and/or delivered with. Nothing herein shall be construed as a sale of the Software to a user of this Device.

You shall not reproduce, modify, distribute, reverse engineer, decompile, otherwise alter or use any other means to discover the source code of the Software or any component of the Software. For avoidance of doubt, you are at all times entitled to transfer all rights and obligations to the Software to a third party, solely together with the Device with which you received the Software, provided always that such third party agrees in writing to be bound by these rules. You are granted this license for a term of the useful life of this Device. You can terminate this license by transferring all your rights to the Device on which you have received the Software to a third party in writing. If you fail to comply with any of the terms and conditions set out in this license, it will terminate with immediate effect Sonim and its third party suppliers and licensors are the sole and exclusive owner of and retain all rights, title and interest in and to the Software. Sonim, and, to the extent that the Software contains material or code of a third party, such third party, shall be entitled third party beneficiaries of these terms. The laws of Delaware, United States shall govern the validity, construction and performance of this license.

HAZARDOUS LOCATION USAGE WARNING

Determine by inspection that the following information is made available to the user by one or more of;

- (a) Printed on the label for the battery
- (b) Printed on the label for the host device,
- (c) Printed in the owner's manual, and/
- or (d) Posted in a help file or internet web site.



Do not disassemble or open crush, bend or deform, puncture or shred.



Do not modify or remanufacture, attempt to insert foreign objects into the battery, immerse or expose to water or other liquids, expose to fire, explosion or other hazard.



Only use the battery for the system for which it is specified.



Only use the battery with a charging system that has been qualified with the system per CTIA Certification Requirements for Battery System Compliance to IEEE 1725. Use of an unqualified battery or charger may present a risk of fire, explosion, leakage, or other hazard.



Do not short circuit a battery or allow metallic conductive objects to contact battery terminals.



Replace the battery only with another battery that has been qualified with the system per this standard, IEEE-Std-1725. Use of an unqualified battery may present a risk of fire, explosion, leakage or other hazard. Only authorized service providers shall replace battery. (If the battery is non-user replaceable).



Do not short circuit a battery or allow metallic conductive objects to contact battery terminals.



Promptly dispose of used batteries in accordance with local regulations.



Battery usage by children should be supervised.



Avoid dropping the phone or battery. If the phone or battery is dropped, especially on a hard surface, and the user suspects damage, take it to a service center for inspection.



Improper battery use may result in a fire, explosion or other hazard.

INDEX

A

Account Sync 33
Airplane Mode 20
Alarm 41
Apps 22

B

Backup 40
Battery 7
Battery Usage
 Charging 7
Blocked Numbers 32
Browser 43

C

Calculator 41
Calendar 43
Camera 43
Capturing Screenshot 14
Child Safety 6
Cloud 37
Contacts
 Export
 Import
 Share 21, 31, 32

D

Data Warning 19
Date 30
Display 23
Downloads 40

E

Emergency Alerts 35
Export 32

F

Fieldforce 37
File Explorer 40
FlexT9 29
FM Radio 39

G

Gallery 43

H

HAC 45
Hazardous Location 46
Home Screen 12

I

Import 32

K

Keyboard 29

M

Messages 35
Missed Events 17
Mobile Network 19
Music 39
My Notifications 16

N

Notification 25

O

Operations 14

P

Phone Specifications 10
Power Optimization 7
Push to talk+ 37

Q

Quick Profile Switch 25
Quick Settings 17

R

Restore 40

S

Scout 38
Search 16
Setup wizard 38
Side Connector 39

SMS/MMS Message 35

Sound 24

Sound Recorder 42

Stopwatch 41

Support 38

T

Temperatures 6

Text Entry 14

Time 30

Timer 41

Torch 17

U

Utilities 38

V

Voice commands 40

W

Wallpaper 16

Wi-Fi 18

X

XP5s 11