

sonim®

**XP5plus 5G**

USER GUIDE



# GENERAL INFORMATION

Congratulations on purchasing the Sonim XP5plus 5G mobile phone! This phone has an intuitive, feature-rich user interface that helps you make the most of its capabilities.

## DURABLE DESIGN

The Sonim XP5plus 5G is engineered for ultra durability, featuring an IP68 rating that certifies its resistance to dust and water. This means the device can be submerged up to 6.56 feet (2 meters) for 30 minutes without sustaining damage, making it ideal for harsh and unpredictable environments. It also meets the rigorous MIL-STD-810H military standard, ensuring resilience against extreme conditions such as drops from up to 4.92 feet (1.5 meters), shock, vibration, temperature fluctuations, and is resistant to salt fog, enhancing its suitability for maritime or coastal environments<sup>1</sup>.

## PHONE MODELS COVERED

This user guide covers the **Sonim XP5plus 5G** phone with model number X530 (two versions: with or without knobs).

## What's in the box?

The Sonim XP5plus 5G package includes:

- Sonim XP5plus 5G phone
- Battery
- SIM Card (*installed*)
- Wall Charger
- USB C Cable
- Screwdriver
- Battery Cover
- Quick Start Guide

---

<sup>1</sup> For more information, consult the Sonim XP5plus 5G warranty at <https://www.sonimtech.com/support/warranties>

# Register Your Phone

Please register your phone at <https://sonimtech.my.site.com> to receive product information and updates.



Sonim devices are covered by a 3-year warranty. The battery is covered by a 1-year limited warranty.

## Sonim Support Information

For additional product and support information, visit [www.sonimtech.com](http://www.sonimtech.com) or contact our Sonim Customer Experience Center at <https://www.sonimtech.com/about/contact/>

**Email:** [support@sonimtech.com](mailto:support@sonimtech.com)

**Manufacturer's address:** Sonim, a NEXA company  
2057 Coolidge Street  
Hollywood, FL 33020, United States

**Tel:** 1-833 MY SONIM (1-833-697-6646).

**FirstCare for FirstNet customers:**

1-855-FIRST-SONIM (1-855-347-7876)

24 hours a day, 7 days a week

**Copyright © 2026. Sonim, a NEXA company. All rights reserved.**

Sonim and the Sonim logo are trademarks of Sonim, a NEXA company. Other company and product names may be trademarks or registered trademarks of the respective owners with whom they are associated.



**IMPORTANT:** The XP5plus offers IP68 level protection only when the battery cover and USB port doors are closed.

# TABLE OF CONTENTS

<b>GENERAL INFORMATION</b>	<b>2</b>
Durable Design	2
Phone Models Covered	2
What's in the box?	2
Register Your Phone	3
Sonim Support Information	3
<b>GETTING STARTED</b>	<b>10</b>
Charging the Battery	10
Properly Charging the Device	10
Charging Animation/Icon	11
SIM Card	12
Inserting the SIM Card	12
<b>USING YOUR XP5PLUS 5G</b>	<b>17</b>
Switching On the Phone	18
Phone Operations without SIM	18
Managing the Home Screen	19
Key Description	19
Notification Bar Icons	20
Capturing a Screenshot	24
Change the Input Language	24
Text Entry Options	24
<b>HOME SCREEN MENU OPTIONS</b>	<b>26</b>
Options	26
Wallpaper	26
Search	26
Home Screen Shortcuts	27
System Settings	27
Manage Apps	27
Menu	27
Notifications	28
Quick Settings	28
Wi-Fi	28
Mobile Data	28
Mobile Hotspot	29
Bluetooth	29

Flashlight.....	29
Airplane Mode.....	29
Profiles .....	29
Battery Saver.....	29
Missed Events .....	30
<b>NETWORK AND INTERNET SETTINGS.....</b>	<b>31</b>
Wi-Fi.....	31
Add Network.....	31
Connect to a Network.....	32
Edit a Network.....	32
Forget a Network.....	32
Network Preferences.....	33
Saved Networks .....	33
Non-Carrier Data Usage .....	34
Calls & SMS.....	34
SIMs .....	34
Airplane Mode .....	36
Hotspot and Tethering .....	36
Data Saver.....	37
VPN .....	38
Private DNS .....	38
<b>CONNECTED DEVICES.....</b>	<b>39</b>
Bluetooth .....	39
Pair New Device.....	39
<b>APPS &amp; NOTIFICATIONS.....</b>	<b>40</b>
Recently Opened Apps .....	40
Default Apps .....	40
Permission Manager .....	40
Wireless Emergency Alerts.....	41
Special App Access .....	42
<b>BATTERY SETTINGS.....</b>	<b>43</b>
Battery .....	43
<b>DISPLAY SETTINGS.....</b>	<b>44</b>
Display.....	44
<b>SOUND SETTINGS.....</b>	<b>45</b>

Sound .....	45
To Create a New Profile .....	47
Sound .....	47
Other Sounds and Vibrations .....	48
Notification .....	48
Voice Noise Cancellation .....	48
Quick Profile Switch .....	48
<b>STORAGE SETTINGS .....</b>	<b>49</b>
Storage .....	49
<b>ACCESSIBILITY SETTINGS .....</b>	<b>50</b>
Accessibility .....	50
<b>ACCESSORIES SETTINGS .....</b>	<b>53</b>
Accessories .....	53
AT&T Enhanced PTT Application .....	53
<b>SECURITY SETTINGS .....</b>	<b>54</b>
Security .....	54
<b>PRIVACY SETTINGS .....</b>	<b>56</b>
Privacy .....	56
<b>LOCATION SETTINGS .....</b>	<b>57</b>
Location .....	57
<b>SAFETY &amp; EMERGENCY .....</b>	<b>58</b>
Safety & Emergency .....	58
<b>SYSTEM .....</b>	<b>59</b>
Languages .....	59
Home Screen Shortcuts .....	59
Programmable Keys .....	60
Keyboard .....	61
Date & Time .....	62
System Update .....	63
Reset Options .....	63
<b>ABOUT PHONE .....</b>	<b>65</b>
<b>MANAGING CONTACTS .....</b>	<b>66</b>

Adding Contact for the First Time.....	66
Viewing Contact Details .....	66
Sending a Message from Contacts.....	66
Dialing a Number from Contacts.....	67
Editing the Contact Details.....	67
Deleting a Contact .....	68
Manage Contacts.....	68
Import/Export Contacts .....	68
Blocked Numbers .....	71
Select .....	71
Managing Contact Settings .....	72
Contact List .....	72
Individual Contacts .....	72
<b>MANAGING CALL SETTINGS .....</b>	<b>73</b>
Making a Call.....	73
Direct Dial.....	73
Alternative methods.....	73
Dialing a Number via Contact .....	73
Adding a Contact from Home Screen .....	73
Viewing Call History.....	74
Deleting Call History.....	74
Speed Dial Settings.....	74
Call Settings .....	75
Display Options .....	75
Sounds and Vibration.....	75
Call Duration.....	75
Used Data .....	76
Quick Responses.....	76
Call Accounts.....	76
Blocked Numbers .....	79
Voicemail .....	79
Accessibility.....	80
<b>SENDING MESSAGES .....</b>	<b>81</b>

Sending SMS/MMS Message .....	81
Search .....	82
Deleting Messages .....	82
Wireless Emergency Alerts.....	83
Message Settings.....	83
<b>AT&amp;T EPTT SERVICES.....</b>	<b>85</b>
<b>SONIM SCOUT .....</b>	<b>86</b>
Setup .....	86
Utilities.....	87
Support.....	87
<b>FEATURES.....</b>	<b>88</b>
Browser.....	88
Camera.....	88
Gallery .....	90
Clock.....	91
Alarm.....	91
World Clock .....	91
Countdown .....	91
Timer .....	92
Calendar .....	92
<b>APPLICATIONS .....</b>	<b>94</b>
Downloads .....	94
Backup and Restore.....	94
Voice Commands.....	95
Sound Recorder .....	95
File Explorer.....	96
Music .....	97
FM Radio .....	98
Note.....	99
Calculator .....	99
SIM Toolkit.....	100
<b>KNOB VERSION OPTIONS.....</b>	<b>101</b>
Programmable Keys - Additional Options.....	102
Channel Select Knob .....	103
<b>PHONE SPECIFICATIONS .....</b>	<b>104</b>

<b>SAFETY AND REGULATORY INFORMATION .....</b>	<b>107</b>
Additional Battery Information .....	107
Battery Usage.....	107
Tips to Extend the Battery Life.....	107
Charging the Battery .....	108
Storing Your Phone and Battery .....	108
Verifying and Optimizing Battery Usage.....	109
Environmental Warning.....	110
Safety Guidelines .....	111
Avoid High Temperatures.....	112
Battery Safety Statement .....	113
Child Safety.....	113
Emergency Calls.....	114
Personal Medical Devices.....	114
Protecting Your Personal Information .....	115
Hearing Aid Compatibility (HAC) Rating .....	115
RF Exposure Information (SAR).....	117
Federal Communications Commission Interference Statement.....	118
FCC Compliance Statement.....	119
Additional Statement for Phones .....	119
Caution.....	120
Conditions of Acceptability.....	120
Hazardous Location Usage.....	121
CSA Standard.....	122
Certification.....	122



**NOTE:** Device visuals are for general reference only. The physical product and screen illustrations in this user guide may differ in appearance and functionality, especially after any future software updates.

# GETTING STARTED

## Charging the Battery

The battery delivered with your mobile phone is not fully charged. We recommend fully charging your mobile phone before you use it for the first time.

- For the best charging experience, we recommend you use only the Sonim wall charger (15 Watts) that comes with your device.
- If you use an alternative wall charger,
  - Please ensure it delivers at least 15 Watts (5V DC and 3A) of power.
  - For the fastest charging speed, the charger should be capable of delivering 15 Watts\*.



**\*NOTE:** Using a charger with more than 15 Watts of power is acceptable but does not provide additional benefits.



**NOTE:** If the battery is completely discharged, the charging icon may take several minutes to appear after the charger is connected.

## PROPERLY CHARGING THE DEVICE

### 1. Insert the charger

Insert the charger plug into a power outlet.

### 2. Connect to the phone

The charging port is located on the right side of the phone. Open the port cover and insert the charging connector into the charging port.

## CHARGING ANIMATION/ICON

- If the battery is charged when the phone is switched off, a battery charging animation with the current battery level is displayed.
- If the battery is charged while the phone is switched on, the battery icon on the status bar includes a lightning bolt.
  - The display will show the charging percentage level.
- After the battery is fully charged, the following message is scrolled across the display: "Battery is full." Please unplug the charger.
  - Once unplugged, the battery icon will return to a solid image.



For more battery usage, charging, and handling instructions. Please see the [Additional Battery Information](#) section.

# SIM Card

The Sonim XP5plus 5G device supports eSIM and comes with one SIM card tray and one Memory card tray.

The SIM (Subscriber Identity Module) card associates your network services (for example, phone number, data services, etc.) with your phone. Choose between an eSIM or a physical 4FF SIM for network connectivity. You do not need both.

**For an eSIM**, you can download the eSIM profile by following the device setup process.

**For a physical SIM**, refer to the instructions below on how to insert a SIM card, as well as a micro-SD card (sold separately).



**NOTE:** The device supports Dual SIM Dual Standby (DSDS), allowing you to use both an eSIM and a physical SIM simultaneously for network services.

## Inserting the SIM Card

To install/replace a SIM card, first, power down the phone:

- 1. Unscrew the cover:**  
Use the included screwdriver to unscrew the battery cover screw on the back of the phone counterclockwise.
- 2. Lift the cover:** Lift the back cover to reveal the battery slot.

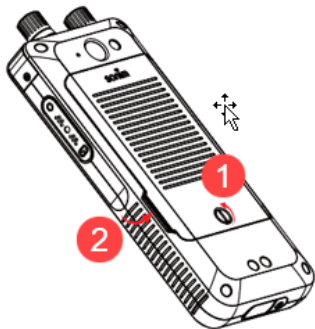

### 3. Remove the battery:

After removing the back cover, lift the battery from the battery compartment.

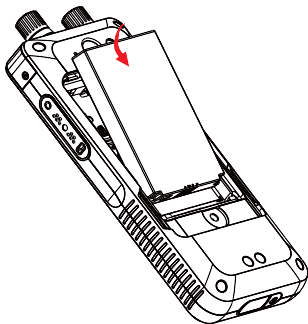

**NOTE:** Please ensure a valid nano SIM card is inserted in your phone.

### 4. Insert the SIM card:

- Slide the SIM door down.
- Rotate open the SIM card door and insert the SIM card with the gold contacts face down.
- Rotate the SIM door closed.
- Slide the door up until you hear a click to lock it into place.

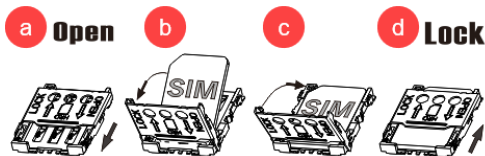
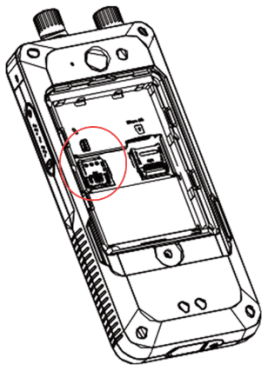

## 5. Replace the Battery and Battery Cover

- a. Place the battery back into the compartment and align the battery terminals.
- b. Close the battery cover.
- c. Use the Sonim-provided screwdriver and tighten the screw on the back cover. Please be careful not to over-tighten the screw.

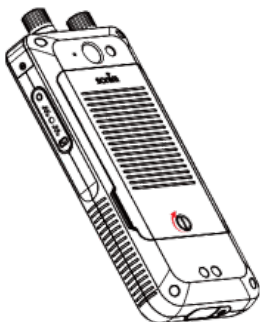
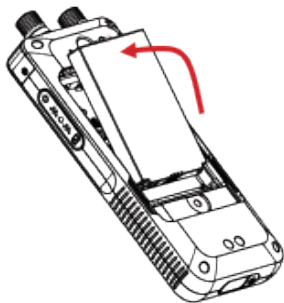

**NOTE:** The torque force of the battery cover screw is 2kgf.cm.

## INSERT A MEMORY CARD

Insert the memory card to add extra storage space for your music, pictures, videos, and more.



**NOTE:** Memory card is optional and sold separately.

To install/replace a memory card (Micro SD), first, power down the phone:

- 1. Unscrew the cover:**  
Use the included screwdriver to unscrew the battery cover screw on the back of the phone.
- 2. Lift the cover:** Lift the back cover to reveal the battery slot.
- 3. Remove the battery:**  
After removing the back cover, lift the battery from the battery compartment.

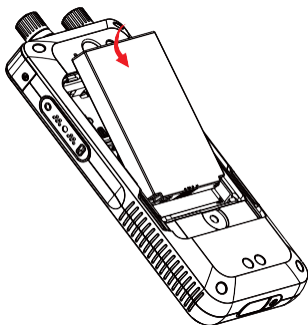
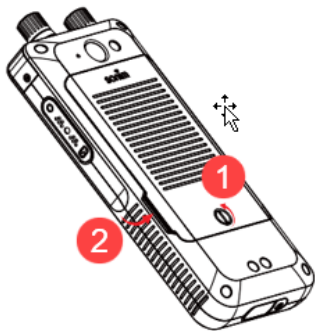

#### 4. Install the Memory card:

- a. Slide the memory card door down.
- b. Rotate open the memory card door and insert the memory card with the gold contacts face down.
- c. Rotate the memory card door closed.
- d. Slide the door up until you hear a click to lock it into place.

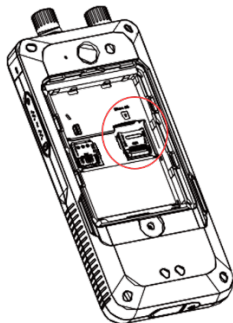

#### 5. Replace the Battery and Battery Cover:

- a. Place the battery back into the compartment and align the battery terminals.
- b. Close the battery cover.
- c. Use the Sonim-provided screwdriver and tighten the screw on the back cover. Please be careful not to over-tighten the screw.

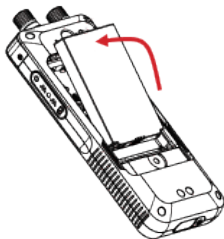

**NOTE:** The torque force of the battery cover screw is 2kgf.cm.

# USING YOUR XP5plus 5G



- |  |                                     |
|--|-------------------------------------|
| <b>1.</b> PTT Dedicated Key                                    | <b>16.</b> Select/Center button     |
| <b>2.</b> Volume Up/Down                                       | <b>17.</b> Navigation Keys          |
| <b>3.</b> Volume Knob*   | <b>18.</b> Text Input Mode          |
| <b>4.</b> Status Bar   | <b>19.</b> Primary Microphone       |
| <b>5.</b> Display  | <b>20.</b> Camera                   |
| <b>6.</b> Dynamic Keys   | <b>21.</b> Flash LED                |
| <b>7.</b> Loudspeaker Key                                      | <b>22.</b> Battery Cover            |
| <b>8.</b> Answer/Accept/Call                                   | <b>23.</b> Battery Cover Screw      |
| <b>9.</b> Voicemail  | <b>24.</b> Charging Pins            |
| <b>10.</b> Loudspeakers  | <b>25.</b> SecureAudio™ Connector   |
| <b>11.</b> Lock / Unlock                                       | <b>26.</b> Lanyard Connection Point |
| <b>12.</b> Channel Selector Knob*                              | <b>27.</b> 2nd Microphone           |
| <b>13.</b> Air Pressure Sensor                                 | <b>28.</b> Emergency Button         |
| <b>14.</b> Back/Clear  | <b>29.</b> USB C                    |
| <b>15.</b> End / Reject / Power On/Off<br>/ Primary Navigation |                                     |

\*Select models only

## Switching On the Phone

Press and hold the **Power On/Off** button for 2 seconds to turn **ON** your phone.

Once your phone has been switched on, the Setup Wizard will appear to guide you through the basic settings on your device.

You will be prompted to select the language you want to use, set up your Wi-Fi connection, and, if applicable, download and install the eSIM. When no SIM card is inserted, set the date and time, and more.

Follow the instructions to finish your phone setup. After successful registration, "AT&T" or "FirstNet" is displayed.



**NOTE:** Ensure a valid SIM card is activated; otherwise, your device will not function correctly on the network.

## Phone Operations without SIM

You can perform the following operations without inserting the SIM card or installing an eSIM in your phone.

- Make an emergency call.
- View and modify all settings except data usage and mobile network-related settings.
- Activate and share files through Bluetooth.
- Access the Internet using Wi-Fi connectivity.
- Access your phonebook, File Explorer, multimedia files, all tools, and applications.
- View and modify your profile settings.

# Managing the Home Screen

After you complete the phone setup, the home screen is displayed. The home screen is the starting point for accessing all the device's features. If at any point you want to immediately access the Home Screen, simply press the Power On/Off key (the key immediately above the #3 key on your keypad).

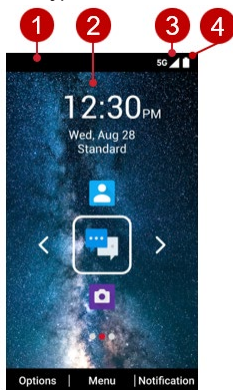

The **Notifications** at the top left of the display screen provide details about various notifications, such as missed calls, new messages, and missed alarms.

The **System Icons** on the top right display the current device status, such as wireless and network connection strength and battery level.



1. Notification Bar
2. Home Screen
3. Signal Strength Bar
4. Battery Indicator

## Key Description

The navigation keys are located below the display screen. From the home screen, use the navigation and selection keys to reach a feature by pressing the:

- A. Up navigation key to launch the **Contacts** app.
- B. Right navigation key to access the **Missed Events** menu.
- C. Down navigation key to launch the **Camera** app.
- D. Left navigation key to access the **Quick Settings** menu.
- E. Selection key to launch the **Messaging** app.

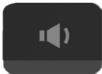













ICONS	DESCRIPTION
	<p><b>Back:</b></p> <p>Opens the previous screens in the working sequence until the home screen is displayed. Once the home screen is displayed, it remains there even when you press the back key.</p> <p>The back key also works as the delete key for the text input field.</p>
 	<p><b>Speaker:</b></p> <p>You can place the call on speaker, and this icon is enabled only when a call is on speaker.</p> <p>For better results in a noisy environment, hold the device 15-20 cm (6-8 inches) from your mouth while speaking in speaker mode.</p>



























**NOTE:** Do not cover the microphone as it may compromise the audio quality.

## Notification Bar Icons

The icons displayed at the top of the screen provide information about the device's status. Details, such as battery charge status and data service, are shown when the phone is in standby mode. Other indicators, such as Bluetooth connectivity status, airplane mode, alarm, call forwarding (only if Always Forward is enabled), and Wi-Fi connectivity, are displayed if the feature is activated.

ICONS	DESCRIPTION
	4G LTE network connected
	5G network connected
	5G Evolution connected
	5G Plus network connected
	Battery level indicator
	Battery charging in progress
	No signal
	Signal strength (full)
	Mobile data disabled
	Data in and out
	Wi-Fi connected
	Wi-Fi
	Location icon

	Bluetooth
	Bluetooth connected
	RTT icon
	Call in progress
	Speaker icon
	FM Radio
	Missed call
	New SMS or MMS
	Alarm activated
	Silent mode activated
	Vibration mode activated
	Headset connected
	Missed events notification
	Hidden notifications
	Airplane mode activated

	Music is playing
	Device storage space is running out
	Profile status - Meeting
	Profile status - Outdoor
	Profile status - Silence
	Event Voice mail
	Roaming
	Roaming with data enabled
	Roaming with data disabled

## Capturing a Screenshot

You can take a screenshot of the current screen, and it is stored in your phone's gallery.

To take a screenshot:

1. Ensure that the image to be captured is displayed on the current screen.
2. Press the **Power** and **Volume down** buttons simultaneously. The screenshot is captured, and it will be stored in the gallery; Or
3. Long-press the **Power** button, then select "**Screenshot**". The screenshot is captured and stored in the gallery.

## Change the Input Language

1. When you enter the text message, you can change the device language by pressing and holding the \* key.
2. You can change the Language from English to Spanish or other languages and vice versa.

## Text Entry Options

When you enter the text message, you can change the text entry options by pressing the # key. Use the navigation key to move up or down the list. Then use the select key to make your selection. The current text entry option is displayed in the top bar.

The various text entry options are:

- **KT9:** Enter the text based on the KT9 dictionary. Only the first letter of the sentence is capitalized. Start by pressing the numeric keys from 2 through 9 only once for the required letter.
  - **Ex 1:** To enter the word "Home", press 4-6-6-3. The word is displayed on the screen as you type.

- **Ex 2:** To enter the word "Hello", press 4-3-5-5-6.  
The word is displayed on the screen as you type.

**NOTE:** If the word does not display correctly, press the right navigation key to scroll through alternative word choices. Use the select key to make your selection.

- **En:** Enter the first letter of the sentence in upper case.
- **EN:** Enter all the text in upper case.
- **en:** Enter all the text in lower case.
- **123:** Enter the numbers.
- **Emojis:** Select the Emojis.
- **Symbols:** Enter a symbol. (You can also press the \* key to quickly get the full symbol list.)

# HOME SCREEN MENU OPTIONS

From the Home screen, you can quickly access multiple menus by using the three dynamic keys or the navigation keys.

## Options

To access the Options menu, start from the home screen and select **Options** by pressing the corresponding dynamic key. The following options are displayed:

- Wallpaper
- Search
- Home screen shortcuts
- System settings
- Manage apps

## WALLPAPER

You can set an image or a photo stored in your gallery as your home screen wallpaper or select pre-loaded wallpaper.

To change the wallpaper, from the Home screen, select **Options > Wallpaper**. Select wallpaper from the pop-up.

- **Gallery:** Includes photos and screenshots taken using the phone's camera.
- **Wallpapers:** Includes images that are pre-loaded with the phone.

## SEARCH

You can search for people, places, music, movies, and much more. Enter the keyword in the search bar, and the results will be displayed. Internet access is needed for the Search feature.



## HOME SCREEN SHORTCUTS

The navigation **Up**, **Center**, and **Down** keys are displayed with their assigned app. You can customize and assign the app of your choice.

For more information, refer to "[Home Screen Shortcuts](#)".

## SYSTEM SETTINGS

System settings refer to the following settings. For more information, refer to their respective sections (as indicated in the table of contents):

- "[Network and Internet Settings](#)"
- "[Connected Devices](#)"
- "[Apps Settings](#)"
- "[Notifications Settings](#)"
- "[Battery Settings](#)"
- "[Storage Settings](#)"
- "[Sound & Vibration Settings](#)"
- "[Display Settings](#)"
- "[Wallpaper Settings](#)"
- "[Accessibility Settings](#)"
- "[Security Settings](#)"
- "[Privacy Settings](#)"
- "[Location Settings](#)"
- "[Safety & Emergency Settings](#)"
- "[System Settings](#)"
- "[About Phone](#)"

## MANAGE APPS

You can manage applications and force stop them. For more information, see "[Apps Settings](#)."

## Menu

To view the main menu, start on the home screen and select **Menu** by pressing the corresponding dynamic key. See the next chapters for instructions.

## Notifications

To view the details of any notifications received, start on the home screen and select **Notification** by pressing the corresponding dynamic key.

When you select **Notification**, the **My Notifications** window appears and displays all your notifications.

## Quick Settings

To access the Quick Settings menu, start on the home screen and press the Left Navigation key.

The following settings are displayed:

- Wi-Fi
- Data
- Mobile Hotspot
- Bluetooth
- Flashlight
- Airplane mode
- Profiles
- Battery Saver

These settings can be enabled or disabled.

### WI-FI

You can enable or disable Wi-Fi settings. For more information, refer to the section "[Wi-Fi](#)".

### MOBILE DATA

You can toggle your Mobile Data settings ON or OFF. For more information, refer to the section "[Non-carrier Data usage](#)".

## MOBILE HOTSPOT

You can enable or disable Mobile hotspot settings. For more information, refer to "[Hotspot and Tethering](#)".

## BLUETOOTH

You can toggle your Bluetooth settings ON or OFF. For more information, refer to the section "[Bluetooth](#)".

## FLASHLIGHT

You can toggle your flashlight (torch) ON or OFF.

## AIRPLANE MODE

Toggle the button to enable or disable the Airplane Mode. For more information, refer to the section "[Airplane Mode](#)."

## PROFILES

You can select the profile from the list:

- Standard
- Outdoor
- Silence
- Meeting

For more information, refer to the section "[Sound & Vibration](#)".

## BATTERY SAVER

Toggle the button to enable or disable the Battery Saver feature. Battery Saver activates a dark theme and limits or disables background activity, some visual effects, certain features, and some network connections.

For more information, refer to the section "[Battery Settings](#)".

## Missed Events

To view the missed events from the home screen, press the Right navigation key.

Missed events refer to any calls or events that were saved earlier on the device.

The missed events can be:

- Missed calls
- Calendar events
- New messages
- Alarm
- New Voicemail



# NETWORK AND INTERNET SETTINGS

## Wi-Fi

Wi-Fi is a wireless network technology that provides internet access at a distance of up to 100 feet, depending on the Wi-Fi router and surrounding conditions.

You can access the internet when you connect your XP5plus 5G to a Wi-Fi network.

To connect your phone to a Wi-Fi network:

1. From the **Home** screen, select **Menu > Settings** (  ) > **Network & Internet** (  ).
2. Select **Internet > Wi-Fi** and turn ON.  
A list of Wi-Fi access points present within your phone's accessible range are displayed.
3. Select your preferred network. Enter the **Password** (if it is a secured network) and select **Connect**. To verify the password before connecting, enable **Show password**.



**NOTE:** It is always recommended to make your Wi-Fi network connection secure and also to connect your phone to a secure network.

## ADD NETWORK

1. In the **Internet** settings screen, select **Add network**.
2. Enter the following details or select Scan QR Code, join Wi-Fi by scanning a QR code:
  - **Network name:** The wireless network ID.

- **Security:** Set the security type to None, Enhanced Open, WEP, WPA/WPA2-Personal, WPA3-Personal, WPA/WPA2/WPA3-Enterprise, WPA3-Enterprise, WPA3-Enterprise 192-bit.

Or

- Scan QR code.
3. Enable **Advanced options** to set the Hidden network, Metered and Proxy, IP settings, and Privacy.
  4. Select **Save** to save the network settings.

## CONNECT TO A NETWORK

1. Select a desired network from the list after the Wi-Fi scanning is complete.
2. Enter the password and get connected to the network.

## EDIT A NETWORK

1. Select connected network.
2. Press the **OK** key. You can change or update the network password and other advanced options such as **Metered**, **Proxy**, **IP settings**, etc.



## FORGET A NETWORK

1. Press and hold the connected network you want to forget.
2. Select **Forget**.

The selected network gets disconnected and displayed in the Wi-Fi list.



If you need to connect to the same network, enter the password.

## NETWORK PREFERENCES

1. From the **Home** screen, select **Menu > Settings** (  ) > **Network & Internet** (  ).
2. In the **Internet** settings screen, select **Network Preferences**.
3. The following options are displayed:
  - **Turn on Wi-Fi automatically:** Enable this option to receive notifications when a high-quality saved network is available, such as your home network.
  - **Notify for public networks:** Enable this option to receive notifications when a high-quality public network becomes available.
  - **Passpoint:** Enable this option to seamlessly connect to Passpoint enabled Wi-Fi access points without needing a password.
  - **Switch to mobile data automatically:** Enable this option to automatically switch to mobile data when Wi-Fi is unavailable.
  - **Install certificates:** You can browse a certificate for installation.
  - **Wi-Fi Direct:** This allows you to connect directly from XP5plus 5G to another device, a PC, or a television.



## SAVED NETWORKS

If your XP5plus 5G is connected to a Wi-Fi network, you can view all the saved Wi-Fi networks in your device.



1. From the **Home** screen, select **Menu > Settings** (  ) > **Network & internet** (  ).
2. In the **Internet** settings screen, select **Saved Networks**.
3. All the saved Wi-Fi networks are displayed.

## NON-CARRIER DATA USAGE



To monitor your data usage, adjust your data usage settings.

1. From the **Home** screen, select **Menu > Settings** (  ) > **Network & Internet** (  ).
2. Select **Internet > Non-carrier data usage**.
3. When Wi-Fi is enabled, it shows the data used for a particular time frame.

## Calls & SMS

1. From the **Home** screen, select **Menu > Settings** (  ) > **Network & Internet** (  ).
2. Select **Calls & SMS**.
  - **Calls:** choose a SIM to use for calls.
  - **SMS:** Select a SIM card to use for sending messages.

## SIMs

1. From the **Home** screen, select **Menu > Settings** (  ) > **Network & Internet** (  ).
2. Select **SIMs**. You can select a SIM to view the following detailed info:
  - **Data preference:** Choose a SIM to use for data connection.
  - **Calls preference:** Choose a SIM to use for calls.
  - **SMS preference:** Choose a SIM to use for sending and receiving messages.

- **Mobile data:** Enable Mobile data to get connected to the internet and use mobile data services such as email, web browsing, and push notifications over the cellular network.
- **Data during calls:** Enable this option to allow this SIM to be used for mobile data only during calls.
- **Roaming:** Enable Roaming to connect to data services when on a different network or outside your home country.



**NOTE:** You may need to activate this service with your carrier before accessing the roaming network.

- **App data usage:** Data usage refers to the amount of data utilized by your phone during data transfers through the internet. The data usage charges are dependent on the wireless plan provided by your service provider.
- **Data warning & limit:** To set the data usage limit.
- **Enable 5G:** Enable or disable 5G.
- **Preferred network type:** Select network type.
  - 5G (recommended)
  - LTE
- **Automatically select network:** Turn ON this option to get connected to the network automatically.
- **Choose network:** Your network operator name is displayed.
- **Access Point Names:** You can view the access points related to your SIM provider.

- **Use Controlled PLMN:** View the list of defined PLMNs in priority order. You can add new PLMN.
3. Select **eSIM management**. You can select an eSIM to turn it on or off, and manage the following operations:
    - **Add eSIM:** Add a new eSIM.
    - **Get EID:** View your device's EID.
    - **Reset eSIM:** Remove all eSIMs from the device.

## Airplane Mode



When your phone is set in airplane mode, network and mobile data connectivity are disabled, but you can access your camera, media files, and other features that do not require mobile connectivity.

To activate airplane mode:

1. From the **Home** screen, select **Menu > Settings** (  ) > **Network & Internet** (  ).
2. Enable **Airplane mode**.

## Hotspot and Tethering

You can use hotspot and tethering to share your mobile data connection with other devices. You can share a mobile data connection via USB/mobile hotspot/Bluetooth.

1. From **Home** screen, select **Menu > Settings** (  ) > **Network & Internet** (  ).
2. Select **Hotspot & tethering**.
3. **Mobile hotspot:** When you turn **ON** mobile hotspot, it uses mobile data from your plan whenever you are not connected to Wi-Fi. And also, you can share your mobile data connection with other devices. You can set up the mobile hotspot details by entering the following details:



- **Hotspot name:** Enter the hotspot name.
  - **Security:** Select the security from the drop-down list.
  - **Hotspot Password:** You have the option to set a password for your Hotspot, which must contain at least 8 characters.
  - **AP Band:** Select preferred band.
  - **AP channel selected:** Select preferred channel number.
  - **Mobile Hotspot turn-off timer:** Auto disables Mobile Hotspot after 10 minutes of inactivity.
  - **Maximum connections:** Your XP5plus 5G Mobile Hotspot may support up to 10 devices at one time.
  - **Connected Devices List:** This will show the list of devices currently connected to your XP5plus 5G.
  - **Allowed devices:** You can turn this feature **ON** to allow connected devices to add other devices.
4. **USB tethering:** Tethering is enabled only when the USB is connected to the device. This will allow the XP5plus 5G to share the internet connection via USB.
  5. **Bluetooth tethering:** When you activate Bluetooth tethering, you can share your phone's internet connection with other Bluetooth paired devices.

## Data Saver



Some applications actively use data when running in the background.

Enable **Data Saver** to restrict apps from using data in the background.

## VPN

1. From the **Home** screen, select **Menu > Settings** (  ) > **Network & Internet** (  ).
2. Select **VPN**.
3. Select **Add**.
4. In the **Edit VPN profile** screen, enter the **Name**, **Type** (select from the drop-down list), and the **server address**.
5. Enter your **Username** and **password**.
6. Select **Save**.

## Private DNS

1. From the **Home** screen, select **Menu > Settings** (  ) > **Network & Internet** (  ).
2. Select **Private DNS**. The following Private DNS Mode options are displayed:
  - Off
  - Automatic
  - Private DNS provider hostname

# CONNECTED DEVICES

## Bluetooth

Bluetooth is a short-range wireless communication technology used to communicate between devices over a distance of approximately 30 feet.



You can perform the following tasks using Bluetooth paired devices:

- Transfer media files and contacts between connected mobile devices using Bluetooth.
- Use Bluetooth connected headphones for playing media files.
- Bluetooth connected headsets can be connected and used during telephone calls.

### PAIR NEW DEVICE

You can activate Bluetooth and pair your XP5plus 5G device with other Bluetooth devices:



A list of paired Bluetooth devices is displayed. Ensure that Bluetooth is activated on the other device too.

1. From the **Home** screen, select **Menu > Settings** (  ) > **Connected devices** (  ) > **Connection Preferences > Bluetooth** > enable Bluetooth.
2. Select **Pair new device** to pair a new device. The device will start searching nearby Bluetooth devices. Available devices are listed.
3. Select the desired device from the list. It will start pairing with the selected device. A confirmation message is displayed to pair the device. Select **Pair**.



To view the files received via Bluetooth, go to **Connection preference > Files received via Bluetooth**.

# APPS & NOTIFICATIONS



## Recently Opened Apps

1. From the **Home** screen, select **Menu > Settings** (  )  
> **Apps & Notifications** (  ).
2. You can view recently opened apps. Select **SEE ALL APPS** to view the list of apps installed on the device.
3. You can change the preferences for installed apps by pressing the **OK** key.
4. You can reset all preferences you set for the apps by selecting the **Reset app**.
5. All the application information will be displayed when you select **Show system**.

## Default Apps



1. From the **Home** screen, select **Menu > Settings** (  )  
> **Apps & Notifications** (  ).
2. Select **Default apps**. The list of default apps on the device is displayed.

## Permission Manager

1. From the **Home** screen, select **Menu > Settings** (  )  
> **Apps & Notifications** (  ).
2. Select **Permissions manager**.

App permissions govern what your app is allowed to do and access.

# Wireless Emergency Alerts

1. From the **Home** screen, select **Menu > Settings** (  ) > **Apps & Notifications** (  ) . > **Advanced > Wireless emergency alerts**.

**Allow alerts:** Enable this option to receive wireless emergency alert notifications.



- **Public safety messages:** Enable to receive public safety messages (recommended actions that can save lives and property).
- **AMBER Alerts:** Enable this option to get the child abduction and emergency bulletins.
- **Extreme threats:** Enable this option to get the extreme threat alerts to life and property. For example, Tsunami, Tornado, Extreme wind, Hurricane, and Typhoon warnings.
- **Severe threats:** Enable this option to get severe threat alerts for life and property. For example, Storm surge, Flash flood, and Dust storm warnings.
- **State and local tests:** Enable to receive test messages from state and local authorities.
- **Emergency alert history:** If you have any active emergency alerts, it is displayed in Alert History

## Alert Preferences:

- **Vibration:** Enable this option to set the device on vibrate while receiving the alert.
- **Audio:** Enable this option to receive audio during the alert.

- **Alert Reminder:** You can set the following time duration for alert reminder sound: Once, Every 2 minutes, Every 15 minutes, and Never.
- **Spanish:** Receive emergency alerts in Spanish when possible.

## Special App Access



1. From the **Home** screen, select **Menu > Settings** (  )  
> **Apps & Notifications** (  ).
2. Select **Special app access**.

The following settings are displayed:

- ALL files access
- Battery optimization
- Wi-Fi control





# BATTERY SETTINGS

## Battery

1. From the **Home** screen, select **Menu > Settings** (  )  
> **Battery** (  ).
2. Set the Battery saver **ON** by selecting the option given to turn on automatically.
  - **Set a schedule:** You have options to set the battery saver:
    - No schedule
    - Based on percentage
  - **Turn off when charged:** Battery Saver turns off when your phone is at 90%.
3. Turn on the **Battery LED** light.
4. **Battery percentage:** Show battery percentage in status bar.
5. Turn on the **Battery Manager** to detect when apps drain battery.
6. In **Last Full Charge**, it shows when the battery is fully charged.
7. The Screen usage duration is displayed.
8. **Screen usage since full charge:** You can view the different applications' usage after the battery is fully charged.
9. Battery usage data is approximate and can change based on usage.



# DISPLAY SETTINGS

## Display

1. From the **Home** screen, select **Menu > Settings** (  ) > **Display** (  ).
2. To set your phone's display settings, select one of the following options:
  - **Brightness level:** Set the brightness of the phone display. The dimmer the level, the better the battery life.
  - **Wallpaper:** Set the wallpaper for your home screen. You can select from one of the following wallpaper collections:
    - **Gallery** (  ): Includes photos and screenshots taken **using the phone's camera**.
    - **Wallpapers** (  ): Includes images that are pre-loaded with the phone.
3. **Screen timeout:** Set the screen timeout so that the screen brightness is turned down after a specified time of phone inactivity. This setting also optimizes the battery power. The shorter the period, the better battery life. The following are the options:
  - 15 seconds
  - 30 seconds
  - 1 minute
  - 2 minutes
  - 5 minutes
  - 10 minutes
  - 30 minutes.
4. Select **Font size**. Set the font size of the text as displayed on the screen.

# SOUND SETTINGS

## Sound

1. From the **Home** screen, select **Menu > Settings** (  ) > **Sound & vibration** (  ).
2. Select **Profile**, and the following options are displayed:

### STANDARD:

Set to **Standard** and select **Edit**. The following options are displayed:

- **Sound:** You can set Media volume, Ring volume, Alarm volume, Notification volume, Phone ringtone, and Default notification sound. You can enable the **Vibrate when ringing**.
- **Other Sounds:** You can set **Screen lock sounds**, **Charging sounds**, and **key press tones**.
- **Notification:**
  - If the **Notification LED** is enabled, the battery status indication will not be affected.
  - If the **Flash Notification** alert is enabled and the battery level is above 20%, you can use the camera flashlight for missed events.
  - If the **Flash call alert** is enabled, you can use Flash camera light for an incoming voice call.

### OUTDOOR:

Set to **Outdoor** and select **Edit**. The following options are displayed:

- **Sound:** You can set the Media volume, Ring volume, Alarm volume, Notification volume, Phone ringtone, and Default notification sound. You can also enable **Vibrate when ringing**.
- **Other Sounds:** You can set **Screen lock sounds**, **Charging sounds**, and **Key Press tones**.

- **Notification:**
  - If the **Notification LED** is enabled, the battery status indication will not be affected.
  - If the **Flash Notification** alert is enabled and the battery level is above 20%, you can use the camera flashlight for missed events.
  - If the **Flash call alert** is enabled, you can use Flash camera light for an incoming voice call.

## SILENCE:

Set to **Silence** and select **Edit**. The following options are displayed:

- **Sound:** When set to **Silence** mode, this profile blocks all sounds and vibrations, including alarms, music, videos, and games. However, you can make phone calls.
- **Notification:**
  - If the **Notification LED** is enabled, the battery status indication will not be affected.
  - If the **Flash Notification** alert is enabled and the battery level is above 20%, you can use the camera flashlight for missed events.
  - If the **Flash call alert** is enabled, you can use Flash camera light for an incoming voice call.

## MEETING:



Set to **Meeting** and select **Edit**. The following options are displayed:

- **Sound:** You can set the **Media volume** and **Alarm volume**.



**NOTE:** In addition to default profiles, users can create customized profiles.

## TO CREATE A NEW PROFILE

1. From the home screen, select **Menu > Settings** (  ) > **Sound & vibration** (  ).
2. Select **Profiles > Create** (dynamic key).
3. Enter the required profile name.
4. A maximum length of 24 characters is allowed for the profile name, and the name must be unique.
5. Save the new profile after modifying the necessary sound and notification settings.

## SOUND

- **Media volume:** You can increase, decrease, and mute media volume.
- **Alarm volume:** You can increase, decrease, or mute the alarm volume.
- **Ring volume:** You can change the ringer volume to no ringer or ringing.
- **Notification volume:** You can increase, decrease, or mute the notification volume.
- **Vibrate for calls:** Enable or disable vibration for calls, notifications, and alarms.
- **Shortcut to prevent ringing:** Enable this option to prevent ringing.
- **Phone ringtone:** You can select the required ringtone from the list.
- **Default notification sound:** Set the default notification sound from the list.
- **Default alarm sound:** The tone listed here is the default alarm sound.

## OTHER SOUNDS AND VIBRATIONS

- **Dial pad tones:** Enable or disable this option.
- **Screen locking sounds:** Enable or disable this option.
- **Charging sounds and vibrations:** Enable or disable this option.
- **Key press tones:** Enable or disable this option.



## NOTIFICATION

- **Notification Blink light:** This feature enables or disables the notification blink light.
- **Flash notification alert:** If Flash notification alert is enabled and the battery level is above 20%, you can use the camera flashlight for missed events.
- **Flash call alert:** If Flash call alert is enabled, you can use the Flash camera light for an incoming voice call.

## VOICE NOISE CANCELLATION

**FENS:** By default, FENS is enabled and reduces the noise cancellation.



## QUICK PROFILE SWITCH

1. From the home screen, select **Menu > Settings** (  ) > **Sound & vibration** (  ) > **Profile**.
2. Select Quick Profile switch.

You can use this option to switch profiles via the home screen shortcut quickly.

# STORAGE SETTINGS



## Storage

1. From the **Home** screen, select **Menu > Settings** (  ) > **Storage** (  ).
2. You can view the total memory and currently used memory.
3. On **Internal shared** storage, the list of applications is displayed with the memory used for each application.
  - Photos and videos
  - Music and audio
  - Other apps
  - Files
  - System
4. Select **Manage storage > Free up space** to free space from the internal storage.

# ACCESSIBILITY SETTINGS

## Accessibility

You can make websites and applications more accessible to people with disabilities who use mobile phones and other devices.

1. From the **Home** screen, select **Menu > Settings** (  ) > **Accessibility** (  ).
2. **Downloaded apps:**
  - **SCOUT Remote Support:** Enable this option to allow SCOUT Remote Support to view and control screen, and view and perform actions.
  - **Talkback:** When enabled, it helps vision-impaired users interact with their devices. It uses spoken word, vibration, and other audible feedback to tell you what is on your screen.
3. **Display:**
  - **Font size:** You can adjust the font size to meet your visual needs.
4. **Interaction Control:**
  - **Vibrate & haptics:** Enable or disable vibration for calls, notifications, and alarms.
  - **Speaker:** Enable this option to switch audio among earpiece, speaker, and accessory (if attached) during a call.
5. **Captions**
  - **Caption preferences:** When Captions is set to **ON**, you can set the following options:
    - Show captions
    - Caption size and style
    - Language

- **External soft keys:** Enable this option to activate soft keys on the external screen.
  - **TTY mode:** Set any one of the following options:
    - **TTY Off:** Disables TTY mode.
    - **TTY Full:** Enables TTY mode for both incoming and outgoing calls. Set this for both hearing and voice assistance.
    - **TTY HCO:** Enables TTY mode only for incoming calls. Set this for only hearing assistance.
    - **TTY VCO:** Enables TTY mode only for outgoing calls. Set this for only voice assistance.
- 6. RTT (Real Time Text) Visibility:** RTT allows you to use the keypad to type messages back and forth during a call.
- **RTT Call Button:** Set RTT as Visible during call or Always visible.
  - **RTT Tutorial:** View RTT Tutorial.
  - **RTT Transcript:** When RTT Transcript is turned on, you can view the transcript in the call log screen.
- 7. Audio:**
- **Voice command:** When this option turns on, you can long-press the Speaker (  ) key to enable voice command.
  - **Flash notifications:** Flash the camera light or the screen when you receive notifications or when alarms sound.

- **Hearing devices:** Your phone can be used with hearing aids, cochlear implants, and other amplification devices.
- **Audio adjustment:** You can enable or disable mono audio and adjust **audio balance**.

## 8. General - Text-to-speech output:

- **Preferred engine:** The Nuance talkback engine is set as default.
- **Language:** You can select the desired language to adjust the spoken language. The system language is set as the default language.
- **Speech rate:** You can move the speech rate using the slider to adjust how fast or slow the text will be spoken.
- **Pitch:** You can move the pitch value using the slider to adjust how high or low the text will be spoken.  
You can demonstrate a speech synthesis.

# ACCESSORIES SETTINGS

## Accessories

From here, you can manage the Channel Select Module (CSM). This feature allows a Push-to-talk (PTT) device user to switch between different communication channels or talk groups manually.

1. From the **Home** screen, select **Menu > Settings** (  ) > **Accessories**.
2. **CSM Settings**: Select **CSM Settings** and press the select key to turn the feature on or off.
3. Use the Navigation key to scroll down to select your CSM App.

### AT&T ENHANCED PTT APPLICATION

Your Sonim mobile comes with a pre-loaded [AT&T EPTT](#) application. Please contact your service provider for more information about PTT service offerings.





**NOTE:** To use the EPTT service, you must activate your EPTT subscription from AT&T.

# SECURITY SETTINGS

## Security

You can activate and protect your phone from unauthorized access by configuring the security settings.

4. From the **Home** screen, select **Menu > Settings** (  ) > **Security** (  ).

5. **Screen Lock:** Select **Screen Lock** and select one of the following options to configure the phone:

- **None**
- **Press and hold ( \* ) key**
- **PIN:** When enabled, enter your PIN value.

When the phone is locked, unlock it using the PIN. When the phone is locked, you can answer an incoming call without unlocking the phone.

6. **Device admin apps:** Select the apps and activate the device admin apps.

- **Sonim Care:** You can activate this admin app to allow Sonim Care to control how and when the screen locks.
- **Sonim Scout:** You can activate this admin app to allow Sonim Scout to view and control the screen, as well as view and perform actions.



7. **Encryption & credentials:**

- **Encrypt phone:** Select **Encrypt phone** to encrypt your accounts, settings, app and its settings, media, and other files.

- **Storage type:** Displays the storage type.
- **Trusted credentials:** You can view and verify the system and user certificates.
- **User credentials:** You can view and modify stored credentials.
- **Install certificate:** You can install a certificate from storage.
- **Clear credentials:** You can remove all certificates.



# PRIVACY SETTINGS

## Privacy

1. From the **Home** screen, select **Menu > Settings** (  ) > **Privacy** (  ).
2. **Permission Manager:** Apps with the following permissions can access your data:
  - Body sensors
  - Calendar
  - Call logs
  - Camera
  - Contacts
  - Files and Media
  - Location
  - Microphone
  - Phone
  - Physical activity
  - SMS
  - Additional permissions – Power Off Alarm
3. **Show Passwords:** Enable this option to display characters briefly as you type.



# LOCATION SETTINGS

## Location

1. From the **Home** screen, select **Menu > Settings** (  ) > **Location** (  ).
2. Set the **Use Location** to **ON** status.
3. **Recent access**
  - The **No Apps have requested location recently** option is the default setting, and you are able to view recent location requests.
  - **App location permissions:** view which apps have permission to access location services.
4. **Location services**
  - **Wi-Fi Scanning:** Enable Wi-Fi scanning to improve location by allowing system apps and services to detect Wi-Fi networks at any time.
  - **Bluetooth scanning:** Enable Bluetooth scanning to improve location by allowing system apps and services to detect Bluetooth devices at any time.

# Safety & Emergency

## Safety & Emergency

1. From Home screen, select **Menu > Settings** (  ) > **Safety & emergency** (  ).
2. **Emergency information:** Add your medical information, such as your name, address, blood type, allergies, etc.
3. **Emergency SOS:**
  - **Use Emergency SOS:** Turn the Emergency SOS function on. If you have an emergency and need emergency services, you can press the **Power** key 5 times or more quickly to start Emergency SOS.
  - **Play countdown alarm:** When this function is turned on, your device will play a loud sound when Emergency SOS starts.
  - **Call for help:** View your current Emergency call number. You can also change your Emergency number; however, ensure the number you enter is a valid emergency contact. If not, your call may not be answered.

### **IMPORTANT: What to do if you call 911 by accident.**



If you accidentally trigger the e911 feature, do not hang up. It is better to let the call connect and inform the dispatcher that you dialed by mistake. This will prevent a potential "unknown trouble" call where officers are dispatched to your location.



# System

## Languages

You can set the phone's language to any of the languages displayed in the language list.

From the **Home** screen, select **Menu > Settings** (  ) > **System** (  ).

### System Languages

Go to **System languages** and select any language from the list as your preferred language.

The following languages can be set as a preferred language:

- English
- Spanish
- Canadian French
- Simplified Chinese
- Traditional Chinese



All the menu items and user feedback messages will be displayed in the set language.

### Text-to-speech output

You can adjust the **Language**, **Speech rate**, and **Speech pitch**.

## Home Screen Shortcuts



On your XP5plus 5G, you can program the 3 Navigation keys to quickly access and launch the selected apps on your device.

1. From the **Home** screen, select **Menu > Settings** (  ) > **System** (  ).

2. Select **Home screen shortcuts**.
3. Select the **Navigation up** key and select the app you want to launch when you press the **Navigation up** key.
4. Select the **Navigation center** key and select the app you want to launch when you press the **Navigation center** key.
5. Select the **Navigation down** key and select the app you want to launch when you press the **Navigation down** key.

## Programmable Keys

You can assign any application to the programmable key.

1. From the **Home** screen, select **Menu > Settings** (  ) > **System** (  ).
2. Select **Programmable keys**. The following options are displayed:
  - **Knobs**
  - **Volume Up Key**
  - **Volume Down Key**
  - **Select PTT Key app:** Select the app you want to launch when you press the **PTT** key.
  - **Select ALARM Key app:** Select the app you want to launch when you press the **ALARM** key.
  - **Press & hold delay for PTT key:** Select the time for delay when you press and hold the PTT key.

## Push To Talk (PTT)





**NOTE:** Push to Talk requires a subscription to work. Additional charges may apply. Please contact your service provider for more information about PTT service offerings.

You must activate your PTT subscription with the carrier to use the PTT service.

## Keyboard



Manage your keyboard settings.

1. From the **Home** screen, select **Menu > Settings** (  ) > **System** (  ).
2. Select **Keyboard > On-screen keyboard > 12key-keyboard**.
  - **Language:** You can set the input language to either English, Spanish, Canadian French, Korean, Simplified Chinese, or Traditional Chinese.
  - **Switch keyboard language:** You can switch to English, Spanish, Canadian French, Korean, Simplified Chinese, or Traditional Chinese.
  - **Personal dictionary:** You can add the desired custom words to the dictionary.
  - **Auto-capitalization:** The first letter of the new sentence is automatically capitalized.
  - **Double-space period:** If this option is enabled, a period will be inserted when you press the space key twice at the end of a word.
  - **Prediction:** Predicts a new word based on the previous word entered



- **Long press \* to switch language:** When entering text, press and hold \* to switch the language to English, Spanish, Canadian French, Korean, Simplified Chinese, or Traditional Chinese.

## Date & Time



You can set and display the date and time on the phone. You can also select the display format.

1. From the **Home** screen, select **Menu > Settings** (  ) > **System** (  ).
2. Select **Date & time**.
3. Select the following options to configure the phone:
  - Enable **Set time automatically** to synchronize the date and time with the network-provided time.
  - Under **Time zone** settings, enable **Set automatically** to synchronize the time zone with the network provided time.
  - To set the date manually, select **Date**. Scroll and select the date, month, and year. Select **OK**.
  - To set the time manually, select **Time**. Scroll and select the hour and minute. Select **OK**.
  - To set the time zone, select **Time zone**. Select **Region** and select your time zone.
  - **Time Format:**
    - Enable **Use locale default** to set default time.
    - Enable **Use 24-hour format** to set the clock to 24-hour format. By default, the phone is set to **12-hour format**.

# System Update

1. From the **Home** screen, select **Menu > Settings** (  ) > **System** (  ).
2. Select **System update**.
3. Select **Update**. If any updates are required, the update process begins. If no updates are required, a message will be displayed showing that no updates are available for your phone.
4. Select **Wi-Fi only** to check for download updates when Wi-Fi is available.
5. Select **Auto update** to check for updates automatically.

# Reset Options

1. From the **Home** screen, select **Menu > Settings** (  ) > **System** (  ).
2. Select **Reset options**.
3. You can reset the following settings:
  - **Reset mobile network settings:** Reset all network settings, including Wi-Fi, Mobile data, and Bluetooth.
  - **Reset Bluetooth & Wi-Fi:** Reset all Wi-Fi and Bluetooth.
  - **Reset app preferences:** Reset all app preferences, including disabled apps, disabled app notifications, default apps, background data restrictions, etc.
  - **Erase eSIMs:** Erase all downloaded eSIMs. This will not cancel any mobile service plans.
  - **Erase all data (factory reset):** This will completely erase all data (this includes: your contacts, photos, downloaded music, text messages, and 3<sup>rd</sup> party

apps) from your phone's internal storage and reset the device to factory settings, like when receiving it brand new from the factory.

- Back up important data before proceeding, as you will not be able to recover it if you do not.

# About Phone

From the **Home** screen, select **Menu > Settings** (  ) >

**About phone** (  ). The following information is displayed:

## Basic info

- Device name
- Phone Number

## Legal & regulatory

- Legal information

## Device details

- SIM status
- Device Unlock
- Model & Hardware
- IMEI
- System version

## Device identifiers

- IP address
- Wi-Fi MAC address
- Device Wi-Fi MAC address
- Bluetooth address
- Up time
- Build number
- Carrier Configuration Version

# MANAGING CONTACTS

You can use the phonebook to maintain the contact information of your contacts. This feature enables you to add, dial, and send phone numbers, SMS, and MMS messages.

To access the contacts, from the **Home** screen, select **Contacts** (  ). The contacts saved in the phonebook are displayed.

## Adding Contact for the First Time

After inserting the SIM when you switch on the XP5plus 5G for the first time, and there are no contacts listed in the device or SIM, you have two options:

1. Press **Add** from **CSK** (Center Soft Key), enter all the details, and then press **Save** from **CSK** to save the contact. You can also enter a number using the dial pad and select **Add to a contact and** then **Create new contact** to add a new contact. Enter the contact details and select **Save** to save the contact.
2. Select **Options** from **LSK** (Left Soft Key), then select **Import/export** to import contacts from the .vcf file or the SIM card.

## Viewing Contact Details

1. From the **Home** screen, select **Menu > Contacts** (  ).
2. Scroll to the desired contact and select the contact to view the contact details.

## Sending a Message from Contacts

You can send SMS and MMS messages to your contacts.

1. From the **Home** screen, select **Menu > Contacts** (  ).
2. Scroll to the desired contact and select the contact to view the details.
3. Select **Message**.
4. Enter the message and select **Options > Attach photos/videos** to attach the photos and videos.
5. Select **Send**.



**NOTE:** If you attach a media file or a contact to your SMS message, it is converted to an MMS message automatically.

## Dialing a Number from Contacts

1. From the **Home** screen, select **Menu > Contacts** (  ).
2. Scroll to the desired contact and select the contact to view the details.
3. Select the phone number and press the **Center** key to initiate the call.  
Or
4. Select the desired contact from the contact list and press the green **Call** key to initiate the call.

## Editing the Contact Details

1. From the **Home** screen, select **Menu > Contacts** (  ).
2. Scroll to the desired contact and select the contact to view the details.
3. Select **Edit**.
4. Edit the desired details. Select **Save** to save the details.

## Deleting a Contact

1. From the **Home** screen, select **Menu > Contacts** ().
2. Scroll to the desired contact and select the contact to view the contact details.
3. Select **Options > Delete**. The contact is deleted after the confirmation.

## Manage Contacts

On the **Contacts** screen, select **Options key** to view the menu options. Following are the menu options:

### IMPORT/EXPORT CONTACTS

#### Import from .VCF File

1. From the **Home** screen, select **Menu > Contacts** ().
2. Select **Options > Import/export**.
3. Select **Import from .vcf file**.
4. Select the .vcf file.
5. Select **Done**.

The contact is imported to the list.

#### Import from SIM Card

1. From the **Home** screen, select **Menu > Contacts** ().
2. Select **Options > Import/export**.
3. Select **Import from SIM card**.
4. The list of contacts stored in your SIM card is displayed.
5. Select the contact to be moved to the phone.

6. Select **Done**.
7. A confirmation message is displayed. Select **OK** to confirm. The contact is imported to the phone address.

### Export to SIM Card

1. From the **Home** screen, select **Menu > Contacts** ().
2. Select **Options > Import/export**.
3. Select **Export to SIM card**.
4. Select the contact to be exported from Phone to SIM card.
5. Select **Done**.

Selected contacts will be exported to the SIM card.

### Export to .VCF File

1. From **Home** screen, select **Menu > Contacts** ().
2. Select **Options > Import/export**.
3. Select **Export to .vcf file**.
4. Press **Center** key to select the contact to be exported.
5. Select **Done**.

A message is displayed to select the source to save the **.vcf** file.

## Import from Cloud

You can synchronize your cloud contacts, (e.g., google, exchange active sync, and outlook contacts from server to device):

1. From the **Home** screen, select **Menu > Contacts** ().
2. Select **Options > Import/export > Import from cloud**. You can select either account to sync contacts from the selected account server.
3. After finishing the setup process, contacts will be downloaded to your device. Any changes made in the device will be synchronized back to the server.
4. You can change the default contacts storage from the Phone to any account via **Settings. > Default contact storage**, new contacts created afterwards will be backed up to the default storage account automatically.
5. You can delete the account via **Settings > Delete cloud account**.
6. You can also move the phone contacts to cloud via **Settings > Move contacts to cloud account**.

## Share All Contacts

You can send contact information.

1. From the **Home** screen, select **Menu > Contacts** ().
2. Select **Options > Import/export > Share all contacts**. You can use one of the following options to share the desired contact. **Share contact via:**
  - **Bluetooth:** Send the contact details to a Bluetooth device paired with your phone. Select the Bluetooth device to share the contact.
  - **Messaging:** Send the contact details as a multimedia message to any mobile phone.

## BLOCKED NUMBERS

If you wish, you can block numbers. If you block a number, you will not be able to receive calls or text messages from that number.

1. From the **Home** screen, select **Menu > Contacts** ().
2. Select **Options > Blocked numbers**.
3. Turn on **Unknown** to block calls from unidentified callers.
4. You can select **Add** to enter a phone number to block.
5. To unblock a number, select the number you want to unblock, and select **Unblock**.

## SELECT

You can select one or more of your contacts to either Share (via text or Bluetooth) or Delete.

## MANAGING CONTACT SETTINGS

### Contact List

You can set the sort list to view the contacts and display their first or last name first.

1. From the **Home** screen, select **Menu > Contacts** ().
2. Select **Options > Settings**. Set the following options:
  - **Sort by:** Sort the contact names by first name or last name.
  - **Name format:** Set the contact display name to first name or last name.

### Individual Contacts

You can edit and modify ringtones and call receiving settings for individual contacts.

1. From **Home** screen, select **Menu > Contacts** ().
2. Scroll to the desired contact and select the contact to view the contact details.
3. Select **Options key** and select one of the following:
  - **Set Ringtone** to set a specific ringtone for that contact.
  - Check the option **All calls to voicemail** to forward all incoming calls from that contact to your voicemail box.

# MANAGING CALL SETTINGS

## Making a Call

### DIRECT DIAL

1. From the **Home** screen, enter the 10-digit phone number by pressing the corresponding numeric keys.
2. Press the **Call** (green phone icon) key to make a call.

### ALTERNATIVE METHODS

1. From the **Home** screen, select **Menu > Phone** ().
2. The phone screen shows the last dialed number, missed calls, and received calls.
3. Select a call and press the **Call** key to make a call.

## Dialing a Number via Contact

1. From the **Home** screen, select **Menu > Contacts** (.
2. Scroll to the contact and select the contact. The contact details are displayed.
3. Select the phone number to call the contact.

## Adding a Contact from Home Screen

1. From the **Home** screen, enter the number to be dialed.
2. Select **Add to contact**.
3. Select **Create new contact**.
4. In the **Add new contact** screen, add the name and other details for the contact.
5. Select **Save**.

The contact is saved.

## Viewing Call History

1. From the **Home** screen, select **Menu > Phone** (  ).
2. The **Recent calls** screen is displayed with recently called, received, and missed calls.

## Deleting Call History

1. From the **Home** screen, select **Menu > Phone** (  ).
2. On the **Recent calls** screen, select **Options > Delete selected call log**.
3. A confirmation message is displayed to delete the selected call log. Select **Delete** to delete the call log. The selected call log will be deleted.

## Speed Dial Settings

With the Speed dial option, the user can assign a contact to each key present in the keypad (2 to 9). The user needs to long-press the keypad to initiate the call to the assigned contact. NOTE: 1 is always reserved for voicemail.

To set the speed dial:

1. From the **Home** screen, select **Menu > Phone** (  ).
2. On the **Recent calls** screen, select **Options > Speed dial settings**.
3. Assign a contact for each key present in the keypad (2 to 9).
4. Long-press a particular keypad digit (2-9) to initiate a call to the assigned contact.

# Call Settings

## DISPLAY OPTIONS

1. From the **Home** screen, select **Menu > Phone** (  ).
2. On the Recent calls screen, select **Settings > Display options**. You can display contacts using the following options:
  - **Sort by**
    - First name
    - Last name
  - **Name format**
    - First name first
    - Last name first

## SOUNDS AND VIBRATION

You can change the incoming call ringtone, enable vibrate when ringing, and enable audible press tone. To view and modify call settings:

1. From the **Home** screen, select **Menu > Phone** (  ).
2. On the Recent calls screen, select **Settings > Sounds and vibration**. For more information, refer to the "Sound Settings" section.

## CALL DURATION

1. From the **Home** screen, select **Menu > Phone** (  ).
2. On the Recent calls screen, select **Settings > Call duration**.
3. You can view the duration of the last call, total outgoing calls, total incoming calls, all calls, etc.

## USED DATA

1. From the **Home** screen, select **Menu > Phone** (  ).
2. On the Recent calls screen, select **Settings > Used data**.
3. You can view the total sent data, total received data, and all data sent/received.

## QUICK RESPONSES

When you cannot answer an incoming call, you can send a quick response to the caller.

1. From **Home** screen, select **Menu > Phone** (  ).
2. On the Recent calls screen, select **Settings > Quick responses**.
3. Select the specific response message to edit. Edit the message and select **OK**.

## CALL ACCOUNTS

1. From the **Home** screen, select **Menu > Phone** (  ).
2. On the Recent calls screen, select **Settings > Calling accounts**.
  - **Make & Receive Calls:** Vibrating for outgoing call accepted - Turn on to enable vibrating mode for outgoing call accepted.
  - **SIP Accounts:** To add a SIP account and configure your incoming and outgoing preferences:
3. Select **Calls > Calling account > SIP settings and SIP accounts**.
4. Select the **Option** key > **Add account** to configure a new SIP account.

5. Enter the following details and select the **Option** key > **Save** to save the account:

- **Username:** Username to login to SIP account.
- **Password:** Password to login to SIP account.
- **Server:** SIP server details.
- **Optional Settings:** Select to view/modify or hide optional details such as Authentication username, Display name, Outbound proxy address, Port number, Transport type and Send keep-alive.
- **Use SIP calling:** Select **Calling accounts > Use SIP calling**. A dialog is open with the following options:
  - **For all calls:** If this option is selected and when the phone is connected to Wi-Fi network or mobile Internet, each dialed call becomes an Internet call.
  - **Only for SIP calls:** If this option is selected, only SIP call can be dialed.
- **Receive incoming calls:** Enable Receive incoming calls to answer incoming Internet calls.

6. **Speaker boost:** During a call, when the speaker is active, you can use the Speaker Boost function. To activate the speaker, boost function, press the navigation down key during a voice call. The speaker volume will be extra loud when the speaker boost is activated. If you disable this setting, you cannot use the speaker boost function.

7. **Fixed Dialing Numbers:**

- **Enable FDN:** Fixed Dialing Numbers are enabled.
- **Change PIN2:** Change the PIN for FDN access.
- **FDN List:** Manage phone number list.

## 8. Call forwarding:

You can forward your incoming calls to a number in the contacts or a new number, provided your network operator supports this service.

Select one of the following call-forward options:

SETTINGS	DESCRIPTION
<b>Always forward</b>	Forward all incoming calls to a pre-designated number.
<b>When busy</b>	Forward calls when your phone is busy.
<b>When unanswered</b>	Forward calls when you do not answer incoming calls.
<b>When unreachable</b>	Forward calls when your phone is switched off or is out of the coverage area.

## 9. Call barring

SETTINGS	DESCRIPTION
<b>Outgoing call barring</b>	Outgoing calls are barred: <b>Outgoing call, International call, International roaming call</b>
<b>Incoming call barring</b>	You can select either All calls or Roaming calls.
<b>Cancel all call barring</b>	You can cancel the call barring option for all calls.
<b>Change password</b>	You can change the password.

## 10. Additional settings:

- **Caller ID:** When the SIM card is inserted, this option is enabled. This feature is used to display caller details (MSISDN or contact name) to the user.

The number is displayed as a private number if there is no network connection.

- **Call waiting:** When call waiting is enabled and the phone is already engaged in an active mobile call, the incoming number is displayed when you receive a call.

To activate call waiting in the Call settings screen, enable **Call waiting**.

## BLOCKED NUMBERS

You will not receive calls or messages from blocked numbers.

1. From the **Home** screen, select **Menu > Phone** (  ).
2. On the Recent calls screen, select **Settings > Blocked numbers**.
3. Turn on **Unknown** to block calls from unidentified callers.
4. You can select **Add** to enter a phone number to block.
5. To unblock a number, select the number you want to unblock, and select **Unblock**.

## VOICEMAIL

1. From the **Home** screen, select **Menu > Phone** (  ).
2. On the Recent calls screen, select **Settings > Voicemail**.
  - **Notifications:** Enable to receive voicemail message notifications.

- **Advanced Settings:** You can see the service provider and set up the voicemail number.

## ACCESSIBILITY

1. From the **Home** screen, select **Menu > Phone** (  ).
2. On the Recent calls screen, select **Settings > Accessibility**.
  - **TTY mode:** Set any one of the following options:
    - **TTY Off:** Disables TTY mode.
    - **TTY Full:** Enables TTY mode for both incoming and outgoing calls. Set this for both hearing and voice assistance.
    - **TTY HCO:** Enables TTY mode only for incoming calls. Set this for only hearing assistance.
    - **TTY VCO:** Enables TTY mode only for outgoing calls. Set this for only voice assistance.
  - RTT (Real Time Text):
    - **RTT Call Button:** Set RTT as Visible during call or Always visible.
    - **RTT Tutorial:** View RTT Tutorial.
    - **RTT Transcript:** When RTT Transcript is turned on, you can view the transcript in the call log screen.
3. **Hearing aids:** Enable the Hearing aids to set your device to hearing aid compatibility.

# SENDING MESSAGES

SMS and MMS are convenient and inexpensive means of communication. You can send a text message to other people via the SMS service. MMS allows you to send messages by including multimedia content such as pictures, audio files, video files, and so on. You can use your phone's messaging to send SMS and MMS messages to other mobile phones or any other equipment that can receive SMS and MMS.



**NOTE:** The MMS feature is available only if you subscribe to it from your network operator.

To access the message function, from the **Home** screen, select **Messaging**.

## Sending SMS/MMS Message

You can send SMS and MMS messages to contacts in your phonebook and to new numbers that are not present in the phonebook.

1. To create an SMS message, from the **Home** screen, select **Messaging** (  ).
2. Select **New**.
3. Enter the contact's name or the phone number in the **To** field.
  - If you enter letters, all of the contact names starting with that letter and containing that letter will be displayed in a list. Keep typing to reduce the list further or scroll down to select the appropriate contact.
4. Press the **Select** key to continue to the text entry field.
5. Type the message.
6. Press the **Send** dynamic key to send your text message.

**When you add an attachment**, the message is automatically converted to a multimedia message. MMS charges will apply, based on the operator.

You can add any multimedia attachment up to a size of  $\leq 2$  MB.

On a new message screen, select **Options**, and the following options are displayed:

- **Attach photos/videos:** Select a photo or video from the Gallery.
- **Attach others:** You can select any of the following attachments to send a message.
- **Insert from templates:** You can insert an attachment from the template.
- **Insert contact:** You can insert a contact from the phonebook.
- **Discard:** Select **Discard** to delete the message. The message thread is deleted after confirmation.

## Search

1. From **Home** screen, select **Messaging** (  ).
2. Select **Options > Search**.
3. Enter the key word to search for a particular message.

## Deleting Messages

To delete the messages,

1. From the **Home** screen, select **Messaging** (  ).
2. Select the message and select **Options > Delete selected thread**.
3. A confirmation message is displayed. Select **Delete** to delete the selected message.
4. To delete an individual conversation, open the message thread, select the conversation to be deleted, select **Delete**, and confirm the choice.

## Wireless Emergency Alerts

1. From the **Home** screen, select **Messaging** (  ).
2. Select **Options > Wireless Emergency Alert**.
3. You will receive active and emergency alerts from the service provider.

## Message Settings

1. From the Home screen, select **Messaging** (  ).
2. Select **Options > Settings**. The following settings are displayed:

SETTINGS	DESCRIPTION
<b>DISPLAY</b>	
Group notification message	Enable this notification message to auto combine the notification into one group.
<b>STORAGE</b>	
Delete old messages	Delete old messages automatically when the storage limit is reached.
Text message limit	Set the maximum number of SMS messages to be stored. By default, 1000 messages can be stored.
Multimedia message limit	Set the maximum number of MMS messages to be stored. By default, 1000 messages can be stored.
Memory status	Shows the memory used for SMS, MMS and the total memory used.

**SETTINGS****DESCRIPTION****ADVANCED SETTINGS****Text (SMS) messages settings**

Delivery reports	Enable this option to request a delivery receipt for each message you send.
Message template	Edit the quick message template.
SMS signature	Enable this option to edit SMS signature to do SMS signature.
Manage SIM card messages	Manages the messages in the SIM card located under Text Messages.
Enable WAP PUSH Service	Enable to receive service message.

**Multimedia (MMS) messages settings**

Group messaging	Enable and use MMS to send a single message when there are multiple recipients.
Delivery reports	Enable this option to request a delivery receipt for each message you send.
Read reports	Enable this option to request a read receipt for each message you send.
Auto-retrieve	Enable this option to retrieve the messages automatically.
Roaming auto-retrieve	Enable this option to automatically retrieve messages while roaming.
Enable WAP PUSH Service	Enable to receive service message.

# AT&T EPTT SERVICES

Your Sonim mobile comes with a pre-loaded AT&T EPTT application.



**NOTE:** To use the EPTT service, you must activate your EPTT subscription from AT&T.

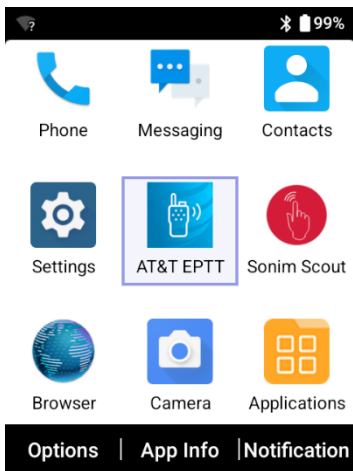

To launch the AT&T Enhanced PTT application, from the **Home** screen, select **Menu > AT&T EPTT** (  ) application (or press the side **PTT Key**).

For more information on AT&T EPTT, go to:

<https://www.business.att.com/products/enhanced-push-to-talk.html>

# SONIM SCOUT

The SonimWare™ SCOUT is a solution that enables users to register with Sonim and utilize several key enterprise features.

A SonimWare™ Cloud account is required to utilize SCOUT capabilities fully. For more information, visit <https://www.sonimcloud.com>.

To access SonimWare™ Scout, from the **Home** screen, select **Menu > Sonim Scout** (  ).

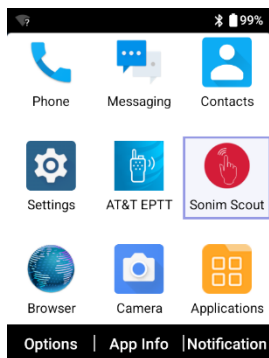

**NOTE:** The initial launch of the app will require acceptance of the Terms and Conditions and End User License Agreement.

## SETUP

The **Setup** tab consists of the following features:

- Sonim Setup Wizard
- SafeGuard
- App Updater
- Kiosk Mode
- MDM Helper

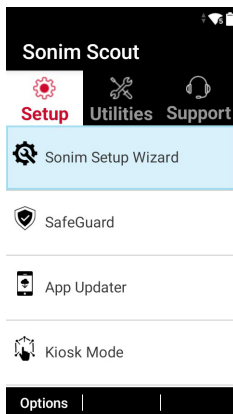

## UTILITIES

The **Utilities** tab consists of the following features:

- Contact Transfer
- Sonim BLE Connect
- Call Screening
- Stealth Mode
- Device Settings
- Repeat Notifications
- USB C Connect
- Messages

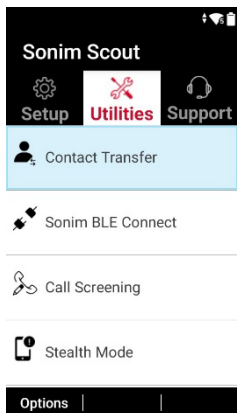

## SUPPORT

The **Support** tab consists of the following features:

- Remote Support
- Sonim Care
- Warranty Registration
- Remote Log Capture
- Device Information
- SCOUT Information
- Support Contact

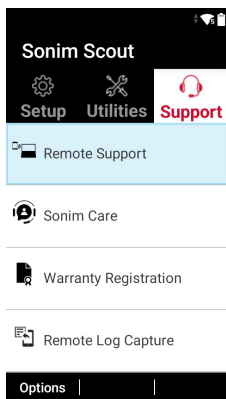

# FEATURES

## Browser

1. From the **Home** screen, select **Menu > Browser** ().
2. Enter the URL to search for the required information or any website.

## Camera

The Sonim XP5plus 5G has a rear camera with 8MP fixed focus for taking pictures and videos. The pictures and videos are saved in the Gallery.

1. From the **Home** screen, select **Menu > Camera** ().
2. Select Camera mode to set the following modes:
  - **Photo:** To shoot a picture in normal mode, press the center key to capture the picture. Use the Left and Right navigation keys to **Zoom in** and **Zoom out**.
  - **Video:** Select **Video**, then press the **Center key** to start or stop a video recording. You cannot pause the recording clip in the middle.
3. Select **Options** to view or change camera settings.



### CAMERA OPTION SETTINGS

<b>Flash</b> – Activate or deactivate the flash	Auto On Off
<b>Timer (Secs)</b> – Select the length of the delay before the camera takes a photo	Off 5, 10 or 15 seconds

<b>Exposure</b> – Control the amount of light in a photo	0, -1, -2, +1, +2
<b>White Balance</b> – Adjust white balance to change the color temperature in a photo	Auto Daylight Cloudy Fluorescent Incandescent
<b>Photo Quality</b> – Adjust photo compression level	Normal Fine Super Fine
<b>Picture size</b> – Adjust photo resolution	8MP, 5MP, 3MP, VGA
<b>Face Detection</b> – Concentrate the autofocus area on a person's face to ensure the primary subject is in focus within the photo	On/Off
<b>Save Location</b> – Include geolocation data with a photo	On/Off
<b>Embed Time and Location</b> – Display time and geolocation data on a photo	On/Off
<b>Anti-Banding</b> – Prevents the appearance of vertical or horizontal lines (banding) on photos with oscillating light sources.	Off, 50Hz, 60Hz, Auto
<b>Shutter Sound</b> – Enable or disable a shutter sound when taking photos	On/Off
<b>Restore Defaults</b> – select then press <b>OK</b> to complete the reset.	



# Gallery

The pictures, videos, and screenshots captured by the camera are stored in the **Gallery**.

1. From the **Home** screen, select **Menu > Applications** ()
2. Select **Gallery** () . You can view the photo album, screenshots, and individual pictures.
3. From the Gallery, you can select **Camera** to switch to the camera to capture pictures or videos.
4. Select the **camera** album,
  - Select **Options**
    - **Slideshow**: Each image in the album will begin to display one by one with a zoom in and crossfade feature. Press **Cancel** to stop.
    - **Group by**: Option to temporarily sort by either Time or Tags.
  - **Select a picture**, and then select **Options**. The following options are displayed:
    - **Delete**: Select this option to delete a picture.
    - **Slideshow**: Select the desired photo to set it as a slideshow.
    - **Details**: You can view the details such as User comment, Flash, Orientation, etc.
    - **Rotate**: Use this option to rotate the picture.
    - **Set picture as**: Select the desired photo to set it as a contact's photo or wallpaper.
5. Select **Share** to share the captured images via **Messaging** or **Bluetooth**.

# Clock

There are four clock features seen in the top menu bar to choose from: Alarm, World clock, Countdown, & Timer. Use the navigation key to scroll left to right.

1. From the **Home** screen, select **Menu > Applications** (  ).
2. Select **Clock** (  ).

## ALARM

- Select **Options > Add**, to create a new alarm.
- Select **Options > Settings** to customize how your alarm works.

## WORLD CLOCK

You can view the current time in various major cities across the country and the world by using the Clock feature.

Select the **World clock icon** (  ) located at the top of the screen. To add a city, select **Add**. Select the check boxes next to the cities to add them to the **Clock**.

Added cities are listed in alphabetical order.

- The local time in the home city is displayed in the upper half of the screen.
- To set the home city, select the desired city from the list. It will be added to the selected cities list. The selected city is set as the home city.

## COUNTDOWN

- Use the numeric keypad to enter your desired length of time.
- You will then have options to **Start** or **Clear** the timer.
- Once timer has begun, you will have option to **Pause**. Once paused, there will be options to **Reset** or **Resume**.



## TIMER

- Press the **Start** button to begin the timer.
- You then have options to keep track of your **Lap** times or to **Pause**.

## Calendar

The Calendar helps you to set appointments, schedule reminders and alerts and repeat them if desired. You can also view your saved tasks on a daily or weekly basis.

To access the calendar:

1. From the **Home** screen, select **Menu > Applications** (  ).
2. Select **Calendar** (  ).
3. To change the calendar view, choose **Agenda**.
  - Make a selection to look at previous events or upcoming events.
  - Select **Options** to select either **Month** or **Settings**.
4. To enter a new event/activity, choose **New Event**.
  - This option allows you to add a new event.
5. Select **Options** to view the list of the following available options:
  - **Today**: Access current date events.
  - **Agenda**: Select each agenda and view the event details.
  - **Search**: You can search for a particular event.
  - **Delete Events**: Select the **event > Options > Done** to delete the selected event. **Select all** to delete all the events.

When you have an event, the **Delete event** option is enabled.

- **Settings:**

- Displays the **General settings** of the calendar.

- Calendar view setting**

- 1. Show week number - on/off
    - 2. Week starts on
    - 3. Use home time zone
    - 4. Clear search history

- Notifications & reminders**



- 5. Notifications – on/off
    - 6. Sound
    - 7. Vibrate – on/off
    - 8. Default reminder time

- Displays the **Build version** in **About Calendar**.

# APPLICATIONS

## Downloads



Use the **Downloads** screen to view, open, or delete the downloaded files.

1. From the **Home** screen, select **Menu** > **Applications** (  ).
2. Select **Downloads** (  ).
3. Select **Options** > **Select** to choose the downloaded file to be opened, viewed, or deleted.

## Backup and Restore

You can back up your data to an SD card (sold separately) if you need to replace your device or would simply like to do so for safety reasons.

To back up your data:

1. From Home screen, select Menu > Applications (  ).
2. Select **Backup and Restore** (  ).
3. Select **Backup**.

All your contacts, Calendar, SMS, and MMS data will be backed up, and media content like photos, audio, and videos will be moved to an SD card.

A warning message appears stating that the Backup may take several minutes. Please do not perform other operations during this time.

4. Select **OK** to start the backup.
5. Select **Restore**.



The contacts, Calendar, SMS, and MMS will be restored.



**NOTE:** Without an SD card, the device cannot be successfully backed up.

# Voice Commands



The XP5plus 5G device includes a voice recognition system for basic commands and voice dialing.

1. From the **Home** screen, select **Menu > Applications** (  ).
2. Select **Voice Commands** (  ).
3. You can give a command by speaking over the phone using your voice. You can perform the voice actions like calling any of the contacts from the phone book, getting directions to a particular destination, and creating reminders, etc.

# Sound Recorder



You can record voice memos using the sound recorder.

To access the sound recorder:

1. From the **Home** screen, select **Menu > Applications** (  ).
2. Select **Sound Recorder** (  ).
  - To record an audio file, select **Record**.
  - To pause the recording, select **Pause**.
  - To stop the recording, select **Stop**.
  - To save the voice memo, select **Save**.
  - To exit without saving, select **Discard**.
  - To play the recorded file, select **List** and the file to be played. Press the **center** key to play the voice memo.
  - Select **Options** to view the following options:
    - **Rename**: Rename the existing file.
    - **Share**: You can share the recording via Bluetooth or Messaging.
  - **Delete**: Deletes the selected item.
  - **Select**: Select a particular file.
  - **Exit**: Exits the Sound Recorder.

# File Explorer

You can view/edit/delete/share the files stored in the phone through **File Explorer** (  ).

1. To view the files, select **Menu > Applications** (  ).
2. Select **File Explorer** (  ).
3. Select any folder and press **Options** to view the following options:

**Recent:** Displays the recent files captured or stored.

- Select **Share** to share the file or folder via Messaging/Bluetooth.
- Select **Move to**, to move the file or folder to other locations.
- Select **Options** to view the following options:
  - **Copy to:** Copy the contents of the folder.
  - **Properties:** View the properties of the folder.
  - **Select:** Select a particular folder.
  - **Exit:** You can select **the Exit option to exit** from **File Explorer**.

**Downloads:** Displays the different folders under Downloads.

- Select **Share** to share the file or folder via Messaging/Bluetooth.
- Select **Move to**, to move the file or folder to other locations.
- Select **Options** to view the following options:
  - **Delete:** Delete the existing folder.
  - **Copy to:** Copy the contents of the folder.
  - **Rename:** Rename the existing folder.
  - **Properties:** View the properties of the folder.
  - **Select:** Select a particular folder.
  - **Sort by:** You can sort the folder using the **Sort** option. Sorting options are: **By Name**,

**By Date Modified**, and **By Size**.

- **Exit:** You can select the **Exit** option to exit from File Explorer.

**X530 (XP5plus 5G):** Displays the different folders in the device drive.



- Select **Search** to search for the file and folder.
- Select **Move to**, to move the folder to other locations.
- Select **Options** to view the following options:
  - **Delete:** Delete the existing folder.
  - **Copy to:** Copy the contents of the folder.
  - **Rename:** Rename the existing folder.
  - **Properties:** View the properties of the folder.
  - **Select:** Select a particular folder.
  - **Sort by:** You can sort the folder using the **Sort** option.
  - **New folder:** You can create a new folder.
  - **Exit:** You can select the **Exit** option to exit File Explorer.



**NOTE:** If SD card is inserted, all the files on the card can be viewed, edited, deleted, or shared from the File Explorer.

## Music



Using the music application, you can play music files and voice memos stored in your phone.

1. From the **Home** screen, select **Menu > Applications** (  )  
> **Music** (  ).
  - Select **Artists** to view the music files sorted based on the artists.
  - Select **Albums** to view the music files sorted by album.

- Select **Songs** to view the complete list of songs stored in your phone.
- Select **Playlists** to access the default playlists in the music folder.
- Select the **Recently added** playlist to view the music files that have been recently added to the music folder.
- Select the **My recordings** playlist to access all your voice memo files.



## FM Radio

You can listen to the radio on FM radio. A wired headset must be connected to enable FM radio.

1. To listen to the radio, select **Menu > Applications** (  ) **> FM Radio** (  ).
2. A pop-up message is displayed: **Connect Headset**. Connect a wired Headset to the allotted slot to enable FM Radio. The **FM radio** icon is displayed on the **Notification** bar.
3. Select **Options > Auto Scan** to scan all the stations. Available channels are displayed.
4. Select **Options > Setting** and the following options are displayed:
  - Regional Band
  - Audio Output Mode
  - Alternate Frequency
  - Revert to Factory Defaults



# Note

You can create notes using the Note app.

1. From the **Home** screen, select **Menu > Applications** (  )  
> **Note** (  ).
2. Press **New** to create a new Note.

# Calculator



The default calculator on this phone is designed for simple mathematical calculations, and the advanced panel is used for scientific calculations.

1. From the **Home** screen, select **Menu > Applications** (  )  
> **Calculator** (  ).
  - To enter the numbers, select the numeric keys.
  - To use mathematical operators, select the respective operation key on the keypad.
  - Select = for the final result.
2. Select **Advanced panel** for scientific calculations.
3. You can toggle between **Basic** panel and **Advanced** panel.

# SIM Toolkit

SIM Toolkit is commonly known as STK, which enables the SIM to initiate actions that can be used for various value-added services.

It displays the operator-specific services. To access the SIM Toolkit,

1. From the **Home** screen, select **Menu > Applications** (  ) > **SIM Toolkit** (  ).
2. It shows My number, which is the SIM card's MSISDN. The number includes a country code and National Destination Code, which identifies the subscriber's operator.
3. It also displays the SIM provider and the respective service details.

# KNOB VERSION OPTIONS

The following features are available **ONLY** on the XP5plus 5G WITH knobs.

From the **Home** screen, select **Options > System Settings > Sounds >** scroll to **Advanced** and select **Knobs**.

- **Volume Level Announcement**

- Set to OFF by default.
- Change to ON to hear the voice alert when adjusting volume using the knob.

- **Volume Control Knob**

The volume control knob will control volume levels based on the setting chosen.

**All active volumes** are set by default.

Other options to select include:

- **Call & PTT volumes**

- manages volumes within voice & PTT calls.

- **Media volume**

- manages media volume levels.

- **Ring volume**

- manages ringtone volume levels.

- **Notification volume**

- manages notification volume levels.

- **Alarm volume**

- manages alarm volume levels.

- **No function**

- If No function is selected, the Volume Level Knob is disabled.

# Programmable Keys - Additional Options

From the **Home** screen, select **Options > System Settings > System > Programmable Keys**.

On the knob version of the XP5plus 5G, you gain two additional programmable keys, allowing you to personalize your device further.

1. **Volume UP key**
  - a. The default is set to increase Volume Up.
2. **Volume DOWN key**
  - a. The default is set to decrease Volume Down.

To program either of these keys to another function, simply click on the respective option and select from the list of available applications.

Your Sonim XP5plus 5G allows you to program six (6) various buttons/settings, and these are found in the **Programmable Keys** menu when handset includes **Knobs\***.

- **\*Volume Up Key**
- **\*0Volume Down Key**
- **Select PTT Key app**
- **Select ALARM Key app**
- **Press & hold delay for PTT Key**

With this setting, you can set the time it takes for the PTT button to activate when pressed. Options are:

- |                |                |
|----------------|----------------|
| • Off          | • 1.75 seconds |
| • 0.1 second   | • 2.00 seconds |
| • 0.25 second  | • 2.25 seconds |
| • 0.50 second  | • 2.50 seconds |
| • 1.00 second  | • 2.75 seconds |
| • 1.25 seconds | • 3.00 seconds |
| • 1.50 seconds |                |

## CHANNEL SELECT KNOB

To control the functionality of the Channel Select Knob, you have three settings:

- 1. No function**

This will disable the Channel Select Knob from functioning.

- 2. Phone Always**

The channel select knob always works.

- 3. Accessory when connected (default)**

The Sonim XP5plus 5G will recognize when an accessory is plugged in. When this setting is chosen and no accessory is detected, it will defer to the phone.

# PHONE SPECIFICATIONS

FEATURE	DESCRIPTION
Chipset	Qualcomm SM4450
Bands Supported	UMTS: I, II, IV, V, VIII
	LTE: 1/2/3/4/5/7/8/12/13/14/20/25 /26/28/29/30/38/41/42/43/48/66/71
	5G: n2/n5/n7/n14/n25/n28/n38/ n41/n48/n66/n71/n77/n78
Down link CA	LTE 2CA, NSA ENDC 2C, SA 2CA
SIM Type	eSIM and 4FF SIM, DSDS
Wi-Fi	Dual band, 802.11 a/b/g/n/ac with hotspot function, excluding Wi-Fi 5G band 2/3
Memory	64GB eMMC + 4GB LPDDR, Micro SD up to 512 GB
Languages Supported	English, Spanish, Canadian French, Traditional Chinese, Simplified Chinese
Battery	Removable Li-ion battery, 3.85V, 3500mAh
<b>CONNECTIVITY</b>	
Bluetooth	BT5.0/BLE (Low Energy)
SMS/MMS	Support SMS and MMS
GPS	GPS/aGPS, Galileo
<b>PHYSICAL CHARACTERISTICS</b>	
Operating Temperature	-4°F to 131°F (-20°C to +55°C)

<b>Protection Class</b>	IP68, IPX9K, MIL-STD-810H, Class I, II, and III, Division 2
<b>Size</b>	With knobs: 163.7 x 65.9 x 21 mm Without knobs: 148.7 x 65.9 x 21 mm
<b>Weight</b>	With knobs: 265g, Without knobs: 277g
<b>Dedicated Keys</b>	PTT Key, Emergency Key
<b>Ports</b>	USB C port, SecureAudio™ Connector
<b>DISPLAY</b>	
<b>Size</b>	2.8 inches (71.12 mm)
<b>Resolution</b>	640x480
<b>Outdoor Visibility</b>	Yes
<b>Capacity</b>	262K
<b>AUDIO</b>	
<b>Microphone</b>	2 Mics with noise and echo cancellation
<b>Speaker</b>	Dual front-facing loudspeakers with smart PA. Supports HD voice and wideband
<b>MULTIMEDIA</b>	
<b>Audio Formats</b>	PCM, AAC, MP3*, AMR-NR/WB, FLAC*, SBC, Vorbis*; AAC+*, eAAC+*, APTX/APTX HD (*only playback is supported.)
<b>Video Formats</b>	HEVC/H265, H264, MPEG-4, H263, VP8, VP9* (*only playback is supported.)
<b>FM Radio</b>	A wired headset for antenna is required
<b>Camera Version</b>	8MP Rear camera
<b>Flashlight</b>	Yes, it is also used for camera flash.



**NOTE:** All knobs features are not applicable to the non-knob variant devices.



**NOTE:** If Flash notification alert is enabled, when the battery is above 20% level, you can use the camera flashlight for missed events.

# SAFETY AND REGULATORY INFORMATION

## Additional Battery Information

### BATTERY USAGE

Your Sonim XP5plus 5G phone comes with a removable battery. For any battery-related questions, please contact the Sonim Customer Experience Center at 1-833-MY-SONIM (1-833-697-6646) or email us at [support@sonimtech.com](mailto:support@sonimtech.com).

- Use only a Sonim XP5plus 5G (X530) certified battery (BAT-03500-11S, supplied by Tianjin Lishen Juyuan New Energy Technology Co., Ltd.) that is designed for this phone model.
- The use of other batteries may void the warranty terms of your phone and cause damage.
- It is recommended to protect the phone and battery from extreme temperature environments and moisture.
- Please keep the battery out of the reach of children.

### TIPS TO EXTEND THE BATTERY LIFE

Follow these tips to extend your phone's battery life.

- If you are not using Wi-Fi, Bluetooth, or GPS, use **Settings** to turn them off. The GPS setting is located in **Settings > Location**.
- Set screen brightness to **Low** and set a shorter Sleep timeout (15 seconds). The display settings are located in **Settings > Display**.
- If you are traveling and do not have access to mobile data or Wi-Fi network, switch to **Airplane mode**.
  - Select **Airplane mode** from **Quick Settings**.

## CHARGING THE BATTERY

The battery delivered with your mobile phone is not fully charged. We recommend charging your device fully before using it for the first time.

- The ambient temperature during charging shall be in the range 32°F to 104°F (0°C to 40°C).
- Only the power supplies with output meeting the SELV<sup>2</sup> requirements can be used for charging. The phone will only allow a maximum input voltage of 5V DC and 3A for USB charging input and 5.5V DC and 2A for Pogo input.
- There is a risk of explosion while charging if the battery has been replaced with an incorrect type.
- If the battery is completely out of charge, it can take several minutes for the charging icon to appear when the charger is connected.



**WARNING:** Never charge, plug in, or unplug your phone when in an inherently unsafe environment (i.e., combustible or explosive atmospheres caused by flammable gases or fumes, dust, etc.).

## STORING YOUR PHONE AND BATTERY

If you plan to store your phone or your battery for an extended time, please follow the recommendations below to ensure long battery life and minimize battery self-discharge:



- Charge your battery to a level between 40% and 80%.
- Store phone and battery separately to minimize battery trickle drain.



---

<sup>2</sup> SELV (Safety Extra-Low Voltage) chargers are designed to ensure user safety by limiting the voltage and providing electrical isolation. Markings on the charger, indicating compliance, vary depending on the country or region in which it is intended for sale and use. Some common logos include "CE," "UK," "FCC," "Intertek," or "CSA." Typically, there is also a logo of a square within a square (□), which indicates the wall charger is double-insulated and does not require grounding.

- Protect the battery terminals to avoid discoloration and potential short circuits with other battery terminals.
- Store the phone in a dry, cool environment that is free from vibration.
- If you use a climate-controlled storage location, set the temperature to 50° to 64 °F (10° to 18 °C) and keep the relative humidity between 40% and 50%.
- Recharge the battery once every 6 months using the original Sonim wall charger and charging cable.

## VERIFYING AND OPTIMIZING BATTERY USAGE

You can check the **battery usage** status and also close some applications to save battery power. Select **Menu > Settings** (  ) > **Battery** (  ).

The current battery level (charging or not charging) is displayed in the middle of the screen, just below the Date information. Select **Settings** (  ) > **Battery** (  ) to view the discharge graph, which shows the battery level over time since you last charged the device, and how long you have been running on battery power.

The list at the bottom of the screen shows the breakdown of battery usage for individual apps and services. Select any listed items for more details. The details screen for some apps includes buttons that allow you to adjust settings affecting power usage or stop the application completely.



**NOTE:** If you Force Stop an application, it may affect the overall performance of not only that application, but the device as well. If you notice any issues with device performance, please power cycle the device.

# Environmental Warning

## DISPOSAL OF OLD ELECTRICAL AND ELECTRONIC EQUIPMENT



The symbol of the crossed-out wheeled bin indicates that this product and any enhancements marked with this symbol cannot be disposed of as unsorted waste; instead, they must be taken to separate collection for end-of-life disposal.

## DISPOSAL OF BATTERY









Please check local regulations for disposal of batteries. The battery should never be placed in municipal waste. Use a battery disposal facility if available.



The device is designed with including but not limited to the following specifications for the environmental conditions range:

- Specification of the Pollution Degree: "2"
- Specification of the Overvoltage Category: I
- Specification for maximum use altitude: not more than 5000m above sea level.
- The product does not use recycled plastics and bio-based plastics. (The content of recycled plastic and bio-based plastic is 0%)
- Does not contain textiles and leather.
- Expanded polystyrene material is not used on product packaging.

## Safety Guidelines

Please read and understand the following safety guidelines before you use the phone. These guidelines provide details to help you operate your phone safely and comply with any applicable legal requirements regarding the use of cellular phones.

	Do not use the phone at a refueling point. Observe restrictions when using radio equipment at fuel depots, chemical plants, or where blasting operations are in progress.
	Electrical interference may obstruct the use of your phone. Observe restrictions in hospitals and near medical equipment.
	Switch off your cellular phone when in an aircraft. Wireless phones can cause interference or danger to an aircraft. In an aircraft, the phone can be used in Airplane mode.
	Do not expose the device to temperatures exceeding 55°C (131°F).
	Adhere to road safety laws. Do not hold/ use a phone while you are driving; find a safe place to stop first. Use hands-free microphone while you are driving.
	Avoid using the phone in close proximity to personal medical devices, such as pacemakers and hearing aids.
	Use only Sonim X530 approved charging equipment to charge your phone and avoid damage to your phone.

	<p>The symbol of the crossed-out wheeled bin indicates that this product, and any enhancements marked with this symbol, cannot be disposed of as unsorted waste but must be taken to separate collection for end-of-life disposal.</p>
	<p>Ensure that only qualified personnel install or repair your phone.</p>
	<p>The Sonim X530 is water-resistant and can be submerged to a depth of up to 6.56 Feet (2 meters) for 30 minutes.</p> <p>Water droplets may condense under the display cover if the phone is immersed in water with a significant temperature drop. This does not indicate water leakage. The droplets will disappear at room temperature.</p> <p>The Sonim X530 is dust-resistant, rugged, and shock-resistant. However, it is not dust-proof or unbreakable if subjected to overwhelming impact. For optimal results and extended product life, it is recommended to protect the Sonim XP5plus 5G from salt water, dust, and strong impacts.</p>

## Avoid High Temperatures

Leaving the device in hot or cold places, such as a closed car in summer or winter conditions, reduces the battery's capacity and lifetime. For optimal results, use the device within the temperature range of -4°F to 131°F (-20°C to +55°C). A device with a hot or cold battery may not work temporarily, even when the battery is fully charged. Battery performance is particularly limited in temperatures well below freezing.

## Battery Safety Statement

- Do not disassemble or open, crush, bend or deform, puncture or shred.
- Do not modify or re-manufacture, attempt to insert foreign objects into the battery, immerse, or expose to water or other liquids, or expose to fire, explosion, or other hazard.
- Only use the battery with a charging system that the system has qualified according to the CTIA Certification Requirements for Battery Systems Compliant with IEEE 1725. Using an unqualified battery or charger may pose a risk of fire, explosion, leakage, or other hazards.
- Do not short-circuit a battery or allow metallic conductive objects to contact battery terminals.
- Promptly dispose of used batteries in accordance with local regulations.
- Avoid dropping the phone or battery. If the phone or battery is dropped, especially on a hard surface, and the user suspects damage, take it to a service center for inspection.
- Battery usage by children should be supervised.
- Improper battery use may result in a fire, explosion, or other hazards.
- Do not use the non-LPS adapter to charge the device. It may cause a fire.

## Child Safety

Do not allow children to play with your mobile phone or its accessories. Keep it out of their reach. They could hurt themselves or others or could accidentally damage the mobile phone or its accessories. Your mobile phone and its accessories may contain small parts that could detach and create a choking hazard.

## Emergency Calls

Mobile phones operate using radio signals, which cannot guarantee a connection under all conditions. Therefore, you should never rely solely on any mobile phone for essential communications, such as medical emergencies.

Emergency calls may not be possible in all areas, on all cellular networks, or when certain network services and/ or mobile phone features are in use. Check with your local service provider.

## Personal Medical Devices

Mobile phones can interfere with the operation of cardiac pacemakers and other implanted medical devices. Please avoid placing your mobile phone over a pacemaker, for example, in your breast pocket. When using the mobile phone, place it at the ear opposite the pacemaker. Maintaining a minimum distance of 15 cm (6 inches) between the mobile phone and the pacemaker limits the risk of interference. If you suspect interference is occurring, immediately turn off your mobile phone. Contact your cardiologist for more information. For other medical devices, consult your physician and the device's manufacturer. Comply with instructions to switch off the device or deactivate the RF transmitter when required, especially when posted in hospitals and airplanes. Equipment used in these places may be sensitive to radio waves emitted by the device and may adversely affect its operation. Also, observe restrictions at gas stations or other areas with flammable atmospheres or when close to electro-explosive devices.

# Protecting Your Personal Information

Your device can store personal information in various locations, including a SIM card, eSIM, memory card, and built-in memory. Be sure to remove or clear all personal information (perform a Factory Reset) before recycling, returning, or giving away your device. Choose your third-party apps and updates carefully and install them only from trusted sources. Some apps can impact your product's performance and/or have access to private information, including account details, call data, location details, and network resources.

Check with local electronic retailers to see if they offer in-store recycling options.

## GUIDELINE FOR HEADPHONE AND EARPHONE



To prevent potential hearing damage, please refrain from listening at high volume levels for extended periods.

## Hearing Aid Compatibility (HAC) Rating

This phone is hearing aid compatible as determined by ANSI C63.19-2019.

This phone has been tested and certified for use with hearing aids for some of the wireless technologies that it uses. However, there may be some newer wireless technologies used in this phone that have not been tested yet for use with hearing aids. It is important to try the different features of this phone thoroughly and in various locations, using your hearing aid or cochlear implant, to determine if you hear any interfering noise. Consult your service provider or the manufacturer of this phone for information on hearing aid compatibility. If you have questions about return or exchange policies, consult your service provider or phone retailer.

The ANSI C63.19-2019 standard does not use the M/T rating system for showing the hearing aid compatibility of the phone; the older version of the standard used, instead, the 2019 version of the standard uses the conversational gains for the phone's hearing aid compatibility capabilities.

The volume control performance has been evaluated according to ANSI C63.19-2019. The lowest conversational gain is 10.00 dB with a hearing aid and 18.27 dB without a hearing aid.

The table below shows the wireless technologies (including frequencies/bands by air interface and codec) that are tested or not tested according to FCC rules and limited waiver DA23-914:

## RF Exposure Information (SAR)

This device meets the government's requirements for exposure to radio waves.

This device is designed and manufactured not to exceed the emission limits for exposure to radio frequency (RF) energy set by the Federal Communications Commission of the U.S. Government.

The exposure standard for a wireless device employs a unit of measurement known as the Specific Absorption Rate, or SAR. The SAR limit set by the FCC is 1.6W/ kg. \*Tests for SAR are conducted using standard operating positions accepted by the FCC with the device transmitting at its highest certified power level in all tested frequency bands. Although the SAR is determined at the highest certified power level, the actual SAR level of the device while operating can be well below the maximum value. This is because the device is designed to operate at multiple power levels, using only the power required to reach the network. In general, the closer you are to a wireless base station antenna, the lower the power output.

The highest SAR value for the model device X530 (Type number S1501 & S1601) as reported to the FCC:

- When tested for use at the ear is .079 W/kg, and
- When worn on the body, as described in this user guide, it is 1.16 W/kg (Body-worn measurements differ among device models, depending upon available accessories and FCC requirements.).
- When the device is set as Hotspot mode as described in this user guide, it is 1.16 W/kg. While there may be differences between the SAR levels of various devices and at various positions, they all meet the government requirement.
- When the device is set as Simultaneous Transmission mode, it is 1.57 W/kg.

The FCC has granted an Equipment Authorization for this model device with all reported SAR levels evaluated as in compliance with the FCC RF exposure guidelines. SAR information on this model device is on file with the FCC and can be found under the Display Grant section of [www.fcc.gov/oet/ea/fccid](http://www.fcc.gov/oet/ea/fccid) after searching on FCC ID: WYPS1501.

For body worn operation, this device has been tested and meets the FCC RF exposure guidelines for use with an accessory that contains no metal and can be positioned a minimum of 10 mm from the body.

When the device is set to hotspot mode, please use it at least 10 mm away from your body. Use of other accessories may not ensure compliance with FCC RF exposure guidelines.

## Federal Communications Commission Interference Statement

This device complies with part 15 of the FCC Rules. Operation is subject to the following two conditions:

- This device may not cause harmful interference, and
- This device must accept any interference received, including interference that may cause undesired operation.

This device has been tested and found to comply with the limits for a Class B digital device, pursuant to Part 15 of the FCC Rules. These limits are designed to provide reasonable protection against harmful interference in a residential installation. This equipment generates, uses, and can radiate radio frequency energy and, if not installed and used in accordance with the instructions, may cause harmful interference to radio communications. However, there is no guarantee that interference will not occur in a particular installation. If this equipment does cause harmful interference to radio or television reception, which can be determined by turning the equipment off and on, the user is encouraged to try to correct the interference by one or more of the following measures:

- Reorient or relocate the receiving antenna.
- Increase the separation between the equipment and receiver.
- Connect the equipment into an outlet on a circuit different from that to which the receiver is connected.
- Consult with the dealer or an experienced radio or TV technician for assistance.

## FCC Compliance Statement

- Any Changes or modifications not expressly approved by the party responsible for compliance could void the user's authority to operate the equipment.
- The antenna(s) used for this transmitter must not be co-located or operated in conjunction with any other antenna or transmitter.
- The country code selection is for the non-US model only and is not available to all US models. Per FCC regulation, all Wi-Fi products marketed in the US must be configured to operate on US-specific channels only.

## Additional Statement for Phones

This device has been tested for compliance with IC SAR values at a typical operating position near the body. To ensure that RF exposure levels are below the levels tested, use accessories with this equipment to maintain a minimum separation distance of 1.0 cm between the body of the user and the device. These accessories should not contain metallic components. It is possible that the accessories used close to the body that do not meet these requirements are not consistent with the SAR limits, and it is advisable to avoid using them.

## Caution

1. The device is designed for indoor use only in the 5150-5250 MHz band to minimize the potential for harmful interference to co-channel mobile satellite systems.
2. The maximum antenna gain permitted for devices in the bands 5250-5350 MHz and 5470-5725 MHz shall comply with the EIRP Limit.
3. The maximum antenna gain permitted for devices in the band 5725-5825 MHz shall comply with the EIRP. Limits specified for point-to-point and non-point-to-point operation as appropriate.
4. Users should also be advised that high-power radars are allocated as primary users (i.e., priority users) of the bands 5250-5350 MHz and 5650-5850 MHz and that these radars could cause interference and/or damage to LE-LAN devices.

## Conditions of Acceptability

The mobile phone shall only be charged in a safe area using a charger approved as SELV or Class 2 equipment against CAN/CSA C22.2 No. 62368-1 and ANSI/UL 62368-1 or equivalent standard as defined in the Canadian Electrical Code C22.1, Section 16-200 and/or National Electrical Code (NFPA 70), article 725.121.

The maximum charging voltage and charging current shall not exceed 5V DC and 3A for USB charging input and 5.5V DC and 2A for Pogo input. The ambient temperature during charging shall be in the range 0° to 40°C (32°F to 104°F).

# Hazardous Location Usage

Do not operate the device in an environment that might be susceptible to radio interference, resulting in danger.<sup>3</sup> Specifically:

## Areas Prohibited By Law

Follow any special rules and regulations and obey all signs and notices. Always turn off the device when instructed or suspect it might cause interference or danger.

Do not operate your device under the following conditions.

- In areas where blasting is in progress
- Where explosive atmospheres may be present
- Near medical equipment
- Near life support equipment, or any equipment that may be susceptible to any form of radio interference.

In such areas, your device **MUST BE POWERED OFF**. Your device can transmit signals that could interfere with this equipment. Some airlines may permit the use of devices while the aircraft is on the ground. When using your device on an airplane, follow the airline's instructions and either power your device off or put it in Airplane Mode as directed. When the aircraft is in the air, your device **MUST** be powered off or placed in Airplane Mode. Your device can transmit signals that could interfere with various onboard systems.

## WARNINGS!

- It is not allowed to connect any external devices to all ports/interfaces (USB) in a hazardous area.
- Explosion hazard: the battery can only be charged or changed in a non-hazardous location.  
Risque d'explosion - les piles doivent être remplacées ou chargées dans un emplacement non-dangereux.

---

<sup>3</sup> U.S. Food and Drug Administration. "Magnets in Cell Phones and Smart Watches May Affect Pacemakers and Other Implanted Medical Devices." Last modified May 13, 2021. <https://www.fda.gov/radiation-emitting-products/cell-phones/magnets-cell-phones-and-smart-watches-may-affect-pacemakers-and-other-implanted-medical-devices>. Federal Communications Commission. "Wireless Devices and Health Concerns." Last modified November 4, 2020. <https://www.fcc.gov/consumers/guides/wireless-devices-and-health-concerns>.

- Do not connect or disconnect through the USB port when energized unless the location is known to be non-hazardous.
- Do not open the battery cover door in hazardous locations.

## CSA Standard

CSA C22.2 No.62368-1-19

ANSI/UL 62368-1, 3rd Edition

CAN/CSAC22.2NO.213-17+UPD 1(2018) +UPD 2 (2019) +UPD 3(2021) (R2022)

ANSI/UL 121201-2021 NINTH EDITION

### CERTIFICATION

cCSAus	CSA Certificate No. CSA25CA80250447X
	Class I, Division 2, Groups A, B, C, and D, T4
	Class II, Division 2, Groups F and G, T4
	Class III, Division 2

Sonim XP5plus 5G USER GUIDE

14 April 2026, v1.05 AT&T EN\_WIP